



OWNER'S MANUAL

Revision 1 – January 24, 2018



CERTIFICATE OF AUTHENTICITY

Thank you for your purchase. This certificate hereby verifies that the spa you have purchased from an Artesian Spas™ (May Manufacturing, LLC.) authorized dealer is authentic, brand new and original. The spa has been crafted and built in the U.S.A in accordance with industry quality standards.

WARRANTY REGISTRATION

Please activate your warranty and register your spa at www.TheGardenSpas.com click SUPPORT then "Click Here to Register Your Spa" or mail the registration card in the back of the Owner's Manual.

Spa Serial #: _____

Spa Model: _____

Date Purchased: _____

Installation Date: _____

Dealer Name: _____

Dealer Telephone #: _____



Table of Contents

IMPORTANT SAFETY INSTRUCTIONS	4
Equipment Assemblies	9
Audio Component Warnings	13
VGB 2008 - Important Safety Instructions.....	15
ELECTRICAL REQUIREMENTS	17
SPA START-UP	17
Selecting a Location.....	17
General Guidelines	17
Outdoor Spa Installation Guidelines	19
Indoor Spa Installation Guidelines	20
Electrical Wiring	20
60 Hz, Garden Spas™ Terminal Options	21
60 Hz, 240 V Residential GFCI Wiring Schematic.....	22
50 Hz, 240 V Residential 2 Pole RCD Wiring Schematic.....	23
50 Hz Single, Two and Three Phase Power Wiring	24
Filling the Spa with Water	25
Powering the Spa On.....	26
Testing the GFCI for a 60 Hz System	27
Priming Pumps.....	27
Water Preparation.....	27
TOPSIDE CONTROLLER INSTRUCTIONS	28
Spa Operation.....	28
Priming the Pumps	28
Exiting Priming Mode.....	28
Pumps	29
Light.....	29
Temperature Operation.....	29
Adjusting the Set Temperature	29
Modes of Operation	29
Standard Mode	30
Economy Mode.....	30

Sleep Mode	30
Freeze Protection	30
Setting the Filter Cycle.....	30
General Messages	31
Sensor Related Messages	33
MAINTAINING THE SPA	34
Draining the Spa	34
Pillow Care.....	35
Jet Care	35
Removing, Installing and Cleaning Filters.....	36
Storing or Winterizing the Spa	36
Spa Cabinet Care	37
Cleaning the Spa Interior	37
Spa Cover Use, Installation and Care.....	37
Chemical Treatment of Water	38
GARDEN SPAS™ WARRANTY	39

List of Figures

Figure 1. Terminal Connections for 240 V and 120 V Service.....	21
Figure 2. GFCI Wiring Schematic for 60 Hz Systems.....	22
Figure 3. Proper Voltage Readings Across Terminals on House Breaker Box, Spa System Box and GFCI.....	23
Figure 4. Wiring Schematic for 50 Hz Systems	23
Figure 5. Single Phase Power – TN and TT Electrical Systems.....	24
Figure 6. Two Phase Power – TN and TT Electrical Systems.....	24
Figure 7. Three Phase Power – TN and TT Electrical Systems	25
Figure 8. Filling Location in Filter Housing	26
Figure 9. Garden Spas™ Topside Controller Face	28
Figure 10. Hose Bib Opening Instructions.....	34

IMPORTANT SAFETY INSTRUCTIONS

IMPORTANTES CONSIGNES DE SÉCURITÉ

Artesian Spas™ (May Manufacturing, LLC.) or any affiliates are not responsible for any defects, failure or damage resulting from improper installation or use, abnormal environmental conditions, cellular signal reception or transmission, and/or viruses or other software problems introduced into this product or other products that are used or purchased products by the user.

PLEASE TAKE THE TIME TO READ ALL OF THESE WARNINGS AND CAUTIONS PRIOR TO USING THE SPA.

PRIÈRE DE LIRE ATTENTIVEMENT TOUTES CES MISES EN GARDE AVANT D'UTILISER LE SPA.

PLEASE be a responsible spa owner. When installing and using this spa, always adhere to basic safety precautions. Be sure to list emergency telephone numbers at the telephone nearest the spa, including physician, hospital, ambulance, police, and the fire department. Be certain to explain safety precautions to all new or occasional users of the spa. Remember, they may not be aware of the possible risks associated with the spa water temperature. Have at least one family member learn CPR (cardiopulmonary resuscitation).

IT COULD SAVE A LIFE!

VEUILLEZ agir de façon responsable en tant que propriétaire de spa. Lorsque vous installez et utilisez ce spa, veuillez prendre les précautions de sécurité de base en tout temps. Conservez près du spa une liste indiquant les numéros de téléphone d'urgence, notamment le médecin, l'hôpital, l'ambulance, la police et les pompiers. Veillez à expliquer les précautions de sécurité à tous ceux qui utilisent votre spa occasionnellement ou pour la première fois. Rappelez-vous qu'ils ne sont probablement pas au courant des risques inhérents à la température de l'eau du spa. Demandez à au moins un membre de la famille d'apprendre la réanimation cardiopulmonaire (RCP).

CELA POURRAIT SAUVER UNE VIE!

READ AND FOLLOW ALL INSTRUCTIONS

1. **WARNING** – To reduce the risk of injury, do not permit children to use this product unless they are closely supervised at all times. The appliance can be used by children aged 8 years and above and persons with reduced physical, sensory or mental capabilities or lack of experience and knowledge if they have been given supervision or instruction concerning use of the appliance in a safe way and understand the hazards involved. Children shall not play with the appliance. Cleaning and user maintenance shall not be made by children without supervision.
2. A wire connector is provided on this unit to connect a minimum 8 AWG (8.4 mm) solid copper conductor between this unit and any metal equipment, metal enclosures of electrical equipment, metal water pipe, or conduit within 5 feet (1.5 m) of the unit.

3. **For cord connected/convertible units:**

DANGER – Risk of Injury

- a) Replace damaged cord immediately.
 - b) Do not bury cord.
 - c) Connect to a grounded, grounding type receptacle only.
4. **DANGER – Risk of Accidental Drowning** – Extreme caution must be exercised to prevent unauthorized access by children. To avoid accidents, ensure that children cannot use this spa unless they are supervised at all times.
 5. **DANGER – Risk of Injury** - The suction fittings in this area are sized to match the specific water flow created by the pump. Should the need arise to replace the suction fittings or the pump, be sure the flow rates are compatible.

Never operate spa if the suction fittings are broken or missing. Never replace a suction fitting with one rated less than the flow rate marked on the original suction fitting.

6. **DANGER – Risk of Electrical Shock – Warning: Before obtaining access to terminals, all supply circuits must be disconnected.** Install at least 5 feet (1.5 m) from all metal surfaces. As an alternative, a spa may be within 5 feet of metal surfaces if each metal surface is permanently connected by a minimum 8 AWG (8.4 mm) solid copper conductor to the wire connector on the terminal box that is provided for this purpose.
7. **DANGER – Risk of Electric Shock** - Do not permit any electrical appliance such as a light, telephone, radio, or television, within 5 feet (1.5 m) of a spa. Parts containing live parts, except parts supplied with safety extra-low voltage not exceeding 12 V, must be inaccessible to a person in the bath. Parts incorporating electrical

components, except remote control devices, must be located or fixed so that they cannot fall into the bath.

8. WARNING – To reduce the risk of injury:

- a)** The water in a spa should never exceed 104°F (40°C). Water temperatures between 100°F (38°C) and 104°F (40°C) are considered safe for a healthy adult. Lower water temperatures are recommended for young children and when spa use exceeds 10 minutes.
- b)** Since excessive water temperatures have a high potential for causing fetal damage during the early months of pregnancy, pregnant or possibly pregnant women should limit spa water temperatures to 100°F (38°C).
- c)** Before entering a spa, the user should measure the water temperature with an accurate thermometer since the tolerance of water temperature regulating devices varies.
- d)** The use of alcohol, drugs, or medication before or during spa use may lead to unconsciousness with the possibility of drowning.
- e)** Obese persons and persons with a history of heart disease, low or high blood pressure, circulatory system problems, or diabetes should consult a physician before using a spa.
- f)** Persons using medication should consult a physician before using a spa since some medication may induce drowsiness while other medication may affect heart rate, blood pressure, and circulation.

9. To ensure proper functionality and component longevity, individual Jet Pumps must not be cycled on and off more than one time every minute.

SAVE THESE INSTRUCTIONS

LIRE ET ADHÉRER À TOUTES LES CONSIGNES

1. **MISE EN GARDE** – Pour réduire le risque de blessure, ne pas laisser les enfants utiliser ce produit sans supervision constante. L'appareil peut être utilisé par des enfants âgés de 8 ans et plus et des personnes ayant des capacités physiques, sensorielles ou mentales réduites ou un manque d'expérience et de connaissances s'ils ont reçu une supervision ou des instructions concernant l'utilisation de l'appareil de manière sécuritaire et comprennent les dangers inhérents. Les enfants ne doivent pas jouer avec l'appareil. Le nettoyage et l'entretien des utilisateurs ne doivent pas être effectués par des enfants sans surveillance.
2. Un raccordeur de fils est compris avec cet appareil afin de brancher un conducteur en cuivre massif d'au moins 8 AWG (8,4 mm) entre cet appareil et toute pièce d'équipement en métal, enveloppes métalliques d'équipement électrique, tuyau en métal ou canalisation à 5 pieds (1,5 m) ou moins de l'appareil.

3. Appareils convertibles/à cordon:

DANGER – Risque de blessure:

a) Remplacer sans tarder le cordon endommagé.

b) Ne pas enterrer le cordon.

c) Raccorder à une mise à la terre.

4. **DANGER – Risque de noyade accidentelle** – Faire preuve d'extrême prudence afin d'empêcher l'accès non autorisé aux enfants. Pour éviter tout accident, veiller à ce que les enfants ne puissent utiliser ce spa à moins d'être supervisés en tout temps.
5. **DANGER – Risque de blessure** – La taille des raccords de succion est déterminée en fonction du débit d'eau spécifique de la pompe. Si les raccords de succion ou la pompe doivent être remplacés, veiller à ce que les débits d'eau soient compatibles.

Ne jamais faire fonctionner un spa si les raccords de succion sont endommagés ou manquants. Ne jamais remplacer un raccord de succion par un autre dont le débit d'eau est inférieur à celui indiqué sur le raccord de succion original.

6. **DANGER – Risque d'électrocution – Avertissement: Avant d'accéder aux bornes, tous les circuits d'alimentation doivent être déconnectés.** Installer à au moins 5 pieds (1,5 m) de toutes les surfaces en métal. Le spa peut également se trouver à moins de 5 pieds des surfaces en métal si chaque surface en métal est raccordée en permanence par un conducteur en cuivre massif d'au moins 8 AWG (8,4 mm) au raccordeur de fils du disjoncteur prévu à cette fin.

7. DANGER – Risque d'électrocution – Interdire tout appareil électrique tel qu'une lampe, un téléphone, une radio ou un téléviseur, à moins de 5 pieds (1,5 m) du spa. Les pièces contenant des pièces en direct, à l'exception des pièces fournies avec une tension extra-basse de sécurité ne dépassant pas 12 V, doivent être inaccessibles à une personne dans le bain. Les pièces incorporant des composants électriques, à l'exception des dispositifs de télécommande, doivent être situées ou fixées de sorte qu'elles ne puissent pas tomber dans le bain.

8. MISE EN GARDE – Pour atténuer le risque de blessure:

a) La température de l'eau du spa ne doit jamais dépasser 40°C (104°F). L'eau dont la température varie entre 38°C (100°F) et 40°C (104°F) est jugée sécuritaire pour un adulte en bonne santé. Pour de jeunes enfants ou un usage d'une durée supérieure à 10 minutes, une température plus basse est conseillée.

b) Étant donné que l'eau très chaude peut causer des dommages au fœtus durant les premiers mois de la grossesse, les femmes enceintes qui utilisent le spa doivent limiter la température à 38°C (100°F).

c) Avant d'entrer dans le spa, l'utilisateur doit vérifier la température de l'eau.

d) La consommation d'alcool, de drogues ou de médicaments avant ou pendant l'utilisation du spa peut causer une perte de conscience entraînant la noyade.

e) Les personnes obèses ainsi que celles qui ont des problèmes cardiaques, une tension artérielle faible ou élevée, des problèmes de circulation sanguine, ou qui souffrent de diabète doivent consulter un médecin avant d'utiliser le spa.

f) Les personnes qui consomment des médicaments doivent consulter un médecin avant d'utiliser le spa, car certains médicaments peuvent favoriser la somnolence, et d'autres peuvent affecter le rythme cardiaque, la tension artérielle et la circulation sanguine.

9. Afin d'assurer le bon fonctionnement et longévité des composants, des pompes à Jet ne doit pas être recyclés et s'éteint plusieurs fois chaque minute.

CONSERVER CES CONSIGNES

Equipment Assemblies

An equipment assembly shall be additionally provided with the following important safety instructions

1. **WARNING** – Risk of Accidental Drowning. Extreme caution must be exercised to prevent unauthorized access by children to avoid accidents, ensure that children cannot use a spa or hot tub unless they are closely supervised at all times. The appliance can be used by children aged 8 years and above and persons with reduced physical, sensory or mental capabilities or lack of experience and knowledge if they have been given supervision or instruction concerning use of the appliance in a safe way and understand the hazards involved. Children shall not play with the appliance. Cleaning and user maintenance shall not be made by children without supervision.
2. **DANGER** – To reduce the risk of drowning from hair and body entrapment, install a suction fitting(s) with a marked flow rate that equals or exceeds the flow rate marked on the equipment assembly.
3. **DANGER** – To reduce the risk of injury, do not remove the suction fittings. Never operate a spa or hot tub if the suction fittings are broken or missing. Never replace a suction fitting with one rated less than the flow rate marked on the equipment assembly.
4. **WARNING** – Risk of Electric Shock. **Warning: Before obtaining access to terminals, all supply circuits must be disconnected.** Install at least 5 feet (1.5 m) from inside wall of hot tub or spa using nonmetallic plumbing.
5. **WARNING** – Risk of Electric Shock. Do not permit any electric appliance, such as a light, telephone, radio, or television, within 5 feet (1.5 m) of a spa or hot tub. Parts containing live parts, except parts supplied with safety extra-low voltage not exceeding 12 V, must be inaccessible to a person in the bath. Parts incorporating electrical components, except remote control devices, must be located or fixed so that they cannot fall into the bath.
6. **WARNING** – To reduce the risk of injury:
 - a) The water in a spa should never exceed 104°F (40°C). Water temperatures between 100°F (38°C) and 104°F (40°C) are considered safe for a healthy adult. Lower water temperatures are recommended for young children and when spa use exceeds 10 minutes.
 - b) Since excessive water temperatures have a high potential for causing fetal damage during the early months of pregnancy, pregnant or possibly pregnant women should limit spa water temperatures to 100°F (38°C).
 - c) Before entering a spa or hot tub, the user should measure the water temperature since the tolerance of water temperature regulating devices varies.
 - d) The use of alcohol, drugs or medication before or during spa or hot tub use may lead to unconsciousness with the possibility of drowning.
 - e) Obese persons and persons with a history of heart disease, low or high blood

pressure, circulatory system problems, or diabetes should consult a physician before using a spa.

- f) Persons using medication should consult a physician before using a spa or hot tub since some medication may induce drowsiness while other medication may affect heart rate, blood pressure, and circulation.

7. For equipment assemblies with a gas heater:

WARNING – Risk of suffocation. This equipment assembly uses a gas heater and is intended for outdoor use only unless proper ventilation can be provided for an indoor installation.

8. For equipment assemblies with a blower:

WARNING – Install blower no less than 1 foot (305 mm) above the maximum water level to prevent water from contacting electrical equipment.

Marking for Equipment Assemblies

 WARNING
REDUCE THE RISK OF ELECTROCUTION 1. Install at least 5 feet from water using non-metallic plumbing. 2. Do not install under spa skirt or within an enclosure that would restrict ventilation. 3. If blower is included, install at least 1 foot above maximum water level.
REDUCE THE RISK OF CHILD DROWNING 1. Supervise children at all times. 2. Attach spa cover after each use. 3. Install a suction guard with marked flow rate no less than 170 GPM to avoid hair and body entrapment.
REDUCE THE RISK OF OVERHEATING 1. Check with a doctor before use if pregnant, diabetic, in poor health, or under medical care. 2. Exit immediately if uncomfortable, dizzy or sleepy. Spa heat can cause hyperthermia and unconsciousness. 3. Spa heat in conjunction with alcohol, drugs, or medication can cause unconsciousness.
WHEN PREGNANT , soaking in hot water for long periods can harm your fetus. Measure water temperature before entering. 1. Do not enter spa if water is hotter than 100°F (38°C). 2. Do not stay in spa for longer than 10 minutes.

SAVE THESE INSTRUCTIONS

MODES D'ASSEMBLAGE

Un mode d'assemblage doit également être fourni et comporter les consignes de sécurité suivantes:

1. **MISE EN GARDE** – Risque de noyade accidentelle. Faire preuve d'extrême prudence afin d'empêcher l'accès non autorisé aux enfants. Pour éviter tout accident, veiller à ce que les enfants ne puissent utiliser ce spa à moins d'être supervisés en tout temps. L'appareil peut être utilisé par des enfants âgés de 8 ans et plus et des personnes ayant des capacités physiques, sensorielles ou mentales réduites ou un manque d'expérience et de connaissances s'ils ont reçu une supervision ou des instructions concernant l'utilisation de l'appareil de manière sécuritaire et comprennent les dangers inhérents. Les enfants ne doivent pas jouer avec l'appareil. Le nettoyage et l'entretien des utilisateurs ne doivent pas être effectués par des enfants sans surveillance.
2. **DANGER** – Pour atténuer le risque de noyade causée par la succion du corps et des cheveux, installer un ou des raccords de succion dont le débit d'eau indiqué est égal ou supérieur à celui qui est indiqué sur l'équipement.
3. **DANGER** – Pour atténuer le risque de blessure, ne pas retirer les raccords de succion. Ne jamais faire fonctionner un spa si les raccords de succion sont endommagés ou manquants. Ne jamais remplacer un raccord de succion par un autre dont le débit d'eau est inférieur à celui indiqué sur l'équipement.
4. **MISE EN GARDE** – Risque d'électrocution. **Avertissement: Avant d'accéder aux bornes, tous les circuits d'alimentation doivent être déconnectés.** Installer au moins 5 pieds (1,5 m) de la paroi intérieure du spa avec de la tuyauterie non métallique.
5. **DANGER** – Risque d'électrocution. Ne pas laisser d'appareil électrique tel qu'une lampe, un téléphone, une radio ou un téléviseur, à moins de 5 pieds (1,5 m) du spa. Les pièces contenant des pièces en direct, à l'exception des pièces fournies avec une tension extra-basse de sécurité ne dépassant pas 12 V, doivent être inaccessibles à une personne dans le bain. Les pièces incorporant des composants électriques, à l'exception des dispositifs de télécommande, doivent être situées ou fixées de sorte qu'elles ne puissent pas tomber dans le bain.
6. **MISE EN GARDE** – Pour atténuer le risque de blessure:
 - a) La température de l'eau du spa ne doit jamais dépasser 40°C (104°F). L'eau dont la température varie entre 38°C (100°F) et 40°C (104°F) est jugée sécuritaire pour un adulte en bonne santé. Pour de jeunes enfants ou un usage d'une durée supérieure à 10 minutes, une température plus basse est conseillée.
 - b) Étant donné que l'eau très chaude peut causer des dommages au fœtus durant les premiers mois de la grossesse. Les femmes enceintes qui utilisent le spa doivent limiter la température à 38°C (100°F).
 - c) Avant d'entrer dans le spa, l'utilisateur doit vérifier la température de l'eau.

- d) La consommation d'alcool, de drogues ou de médicaments avant ou pendant l'utilisation du spa peut causer une perte de conscience entraînant la noyade.
- e) Les personnes obèses ainsi que celles qui ont des problèmes cardiaques, une tension artérielle faible ou élevée, des problèmes de circulation sanguine, ou qui souffrent de diabète doivent consulter un médecin avant d'utiliser le spa.
- f) Les personnes qui consomment des médicaments doivent consulter un médecin avant d'utiliser le spa, car certains médicaments peuvent favoriser la somnolence, et d'autres peuvent affecter le rythme cardiaque, la tension artérielle et la circulation sanguine.

7. Équipement comportant un chauffe-eau à gaz:

IMPORTANTES CONSIGNES DE SÉCURITÉ

MISE EN GARDE – Risque de suffocation. Cet équipement comporte un chauffe-eau à gaz conçu pour un usage à l'extérieur seulement, à moins qu'une ventilation adéquate soit fournie pour une installation à l'intérieur.

8. Équipement comportant une soufflante

MISE EN GARDE – Installer une soufflante au moins 305 mm (1 pied) audessus du niveau de l'eau maximum pour empêcher l'eau d'éclabousser l'équipement électrique.

Étiquette destinée aux modes d'assemblage

 MISE EN GARDE
<p>RÉDUIRE LE RISQUE D'ÉLECTROCUTION</p> <ol style="list-style-type: none"> 1. Installer à 5 pieds et plus de l'eau avec de la tuyauterie non métallique. 2. Ne pas installer sous la plinthe du spa ou dans une enceinte qui limite la ventilation. 3. Si un soufflante est comprise, installer celle-ci au moins 1 pied audessus du niveau maximum de l'eau.
<p>RÉDUIRE LA RISQUE DE NOYADE D'UN ENFANT</p> <ol style="list-style-type: none"> 1. Superviser les enfants en tout temps. 2. Remettre la couverture du spa en place après chaque utilisation. 3. Poser un dispositif de protection contre la succion avec débit d'eau indiqué d'au moins 170
<p>RÉDUIRE LE RISQUE DE SURCHAUFFE</p> <ol style="list-style-type: none"> 1. Consulter un médecin avant usage si vous êtes enceinte, éprouvez des problèmes de santé ou suivez des traitements médicaux. 2. Quitter immédiatement le spa en cas d'inconfort, d'étourdissements ou de somnolence. La chaleur du spa peut causer de l'hyperthermie et la perte de conscience. 3. La chaleur du spa jumelée à l'alcool, aux drogues ou aux médicaments peut causer la perte de
<p>DURANT LA GROSSESSE, le trempage prolongé peut nuire au fœtus. Vérifier la température de l'eau avant d'y entrer.</p> <ol style="list-style-type: none"> 1. Ne pas pénétrer dans le spa si la température de l'eau est supérieure à 38°C (100°F). 2. Ne pas rester dans le spa pendant plus de 10 minutes.

CONSERVER CES CONSIGNES

Audio Component Warnings

Spas equipped with the Audio system should follow these guidelines for safety:

1. **CAUTION** – Risk of Electrical Shock - Do not leave compartment door open.
2. **CAUTION** – Risk of Electrical Shock - Replace components only with identical components.
3. Do not operate the audio controls while inside the spa.
4. **WARNING – Prevent Electrocutation** - Do not connect any auxiliary components (for example cable, additional speakers, headphones, additional audio/video components, etc.) to the system.
5. These units are not provided with an outdoor antennae; when provided, it should be installed in accordance with Article 810 of the National Electrical Code, ANSI/NFPA 70.
6. Do not service this product yourself as opening or removing covers may cause exposure to dangerous voltage or other risk of injury. Refer all servicing to qualified service personnel.
7. When the power supply connections or power supply cord(s) are damaged: if water is entering the audio/video compartment or any electrical equipment compartment area; if the protective shields or barriers are showing signs of deterioration; or if there are signs of other potential damage to the unit, turn off the unit and refer servicing to qualified service personnel.
8. This unit should be subjected to periodic routine maintenance (for example, once every 3 months) to make sure that the unit is operating properly.

KEEP THESE SAFETY INSTRUCTIONS IN A CONVENIENT AND READILY ACCESSIBLE LOCATION!

MISES EN GARDE SUR LES COMPOSANTES DU SYSTÈME DE SON Les utilisateurs d'un spa doté d'un système de son doivent suivre ces consignes de sécurité:

1. **ATTENTION** – Risque d'électrocution – Ne pas laisser la porte du compartiment ouverte.
2. **ATTENTION** – Remplacer les composantes du système de son par des composantes identiques.
3. Ne pas utiliser les commandes audio lorsqu'on se trouve à l'intérieur du spa.
4. **MISE EN GARDE – Prévention du risque d'électrocution** – Ne pas raccorder les composantes auxiliaires (p. ex., câble, hautparleur supplémentaire, casque d'écoute, autres composantes audio/vidéo, etc.) au système.
5. Ces appareils ne comportent pas d'antenne extérieure; lorsque celle-ci est fournie, elle doit être installée conformément à l'article 810 du Code national de l'électricité, ANSI/NFPA 70.
6. Ne pas tenter de réparer le produit soi-même en ouvrant ou en retirant les couvercles, car cela peut exposer l'utilisateur à une tension dangereuse ou autre risque de blessure. Confier toute réparation à un technicien compétent.
7. Raccords d'alimentation ou les cordons d'alimentation endommagés: si l'eau pénètre dans le compartiment audio/vidéo ou tout compartiment de l'équipement électrique; si les écrans ou barrières de protection montrent des signes d'usure; ou si l'appareil semble endommagé, fermer l'appareil et appeler un technicien compétent.
8. Cet appareil doit être entretenu périodiquement (p. ex., tous les trois mois) pour s'assurer qu'il fonctionne adéquatement.

PRIÈRE DE CONSERVER CES CONSIGNES DE SÉCURITÉ DANS UN LIEU PRATIQUE ET FACILE D'ACCÈS!

VGB 2008 - Important Safety Instructions

WARNING!



Read and follow all instructions in this owner's manual and on the equipment. Failure to follow instructions can cause severe injury and/or death.

WARNING – SUCTION ENTRAPMENT HAZARD



Suction in suction outlets and/or suction outlet covers which are damaged, broken, cracked, missing, or unsecured can cause severe injury and/or death due to the following entrapment hazards:

Hair Entrapment: Hair can become entangled in suction outlet cover.

Limb Entrapment: A limb inserted into an opening of a suction outlet sump or suction outlet cover that is damaged, broken, cracked, missing, or not securely attached can result in a mechanical bind or swelling of the limb.

Body Suction Entrapment: A negative pressure applied to a large portion of the body or limbs can result in an entrapment.

Evisceration / Disembowelment Entrapment: A negative pressure applied directly to the intestines through an unprotected suction outlet sump or suction outlet cover which is damaged, broken, cracked, missing, or unsecured can result in evisceration / disembowelment entrapment.

Mechanical Entrapment: There is potential for jewelry, swimsuit, hair decorations, finger, toe, or knuckle to be caught in an opening of a suction outlet cover resulting in mechanical entrapment.



Failure to remove pressure test plugs and/or plugs used in winterization of the pool/spa from the suction outlets can result in an increased potential for suction entrapment as described on the previous page.



Failure to keep suction outlet components clear of debris, such as leaves, dirt, hair, paper and other material, can result in an increased potential for suction entrapment as described above.



Suction outlet components have a finite life. The cover/grate should be inspected frequently and replaced at least every seven years, or if found to be damaged, broken, cracked, missing, or not securely attached.



If the fitting is missing or broken, replace with a fitting of equivalent rating or higher. Use of a lower rated suction fitting could result in entrapment of the body which could result in serious injury including drowning.



Do not use or operate pool, spa, or hot tub if suction fittings are missing, broken or not secured per instructions. The suction fitting is intended to prevent entrapment of the body. Use of the spa hot tub with a missing, broken or improperly secured suction grate may result in serious personal injury including drowning.



When the pool, spa or hot tub is in operation, suction is created at this fitting. Users of the spa or hot tub must be instructed not to come in contact with this fitting in such a way as to block its orifice. If a user of the spa or hot tub blocks this fitting with his/her body, serious personal injury or drowning may occur.



In order to remove the suction cover (for service or winterization), using a Phillips-head screw driver remove the screws. Inspect both the suction cover and suction fitting for any cracks or damages.



It is imperative to securely attach the suction cover to the wall fittings (use only the original supplied screws or obtain original replacements). Do not over tighten the screws. Inspection of fasteners and observation for damaged/tampered with suction fittings is required.



Any and all broken or missing parts must be replaced prior to starting spa or pool pump. Never operate spa or pool without drain cover in place and properly affixed, death or serious injury can result.



Do not exceed the safe flow rate. Do not increase flow through system by increasing pump size or horsepower.



Do not allow children to sit, play or interact with main drains or suction outlet.

ELECTRICAL REQUIREMENTS

The following information is provided for guidance alone in connecting the electrical power supply to the new spa. ***A qualified, licensed, electrician must perform this work. Failure to follow these instructions will terminate all warranty coverage and could result in serious injury or death.***

Garden Spas™ are preset at the factory to run on 120 V, 60 Hz with a 15 A input. This provides for the best performance of the spa.

Codes and Compliance

North America – 60 Hz	
Voltage	120 VAC
Maximum Current	15 A
Number of Wires	4
GFCI Rating	20 A

Export 50 Hz Garden Spas™ are factory preset to run 240 V, 3 wires, 32 A maximum input. This product must always be connected to a residual current device (RCD) having a trip current of not more than 30 mA.

SPA START-UP

Please read each step of the Start-up section prior to performing the step.

Selecting a Location

General Guidelines

In preparation for installing the new Garden Spas™ spa, ensure that the following general guidelines are considered:

Artesian Spas™ (May Manufacturing, LLC.) highly recommends consulting a qualified licensed contractor, engineer and/or architect prior to the installation of any spa to ensure safety, compliance with national, state and local building, electrical and plumbing codes and to account for local geotechnical and environmental conditions. For further assistance, please contact your authorized Garden Spas™ Dealer.

1. Place the spa on a structurally sound and level surface that is large enough for the entire spa. Allow additional space for easy access to equipment compartments and circuit breakers. The location must allow for electrical connections and components to remain dry and away from external sources of water. An adequate

drainage system containing proper drainage away from the spa to deal with overflow water and prevent water from entering the electrical equipment areas is necessary in both semi-inground and above ground installations in order to prevent damage to electronics and tripping circuit breakers. The foundation and/or floor must be able to bear the weight of the expected load consisting of both the filled spa and occupants. Please contact your local authorized dealer and/or contractor to get the maximum weight value for the corresponding spa model.

2. If the spa is placed on the ground, even for a short period of time, it must be supported by stones that are at least 2 inches (5.1 cm) thick and 12 inches (30.5 cm) square. Placing the spa on a solid foundation as soon as possible is recommended.
3. The spa must be on a solid, level foundation which may include a concrete pad, concrete pavers or bricks or a reinforced deck. Concrete foundations must be a minimum 4 inch (10 cm) cement slab that has properly cured for at least 72 hours (this duration may vary due to local conditions and cement properties) and should be reinforced with rebar or mesh. Rebar or mesh reinforcement in the pad should be attached to a #10 AWG bonding wire per national electrical codes. Contact your local building department and/or electrical code compliance inspector for more information and to determine whether an inspection for proper foundation and grounding is required before pouring the concrete slab. **The spa warranty will be voided if an improper installation is performed. Structural damage due to an inadequate or improper foundation is not covered under warranty.**
4. Ensure ample space is provided for any required servicing, that equipment access panels are not blocked and easy access to electrical panels or Ground Fault Circuit Interrupters (GFCI) is available. Installation of all spas must be in accordance with national, state and local electrical codes and rules. **A licensed Electrician must perform the electrical installation of models without a preinstalled cord and conduct a GFCI test procedure in accordance with applicable codes and approved building plans if required. Fixed wiring requires a disconnect device to be incorporated into the wiring in accordance with national, state and local electrical codes and rules. When permitted by applicable codes and rules, a GFCI or Residual-Current Device (RCD) sub-panel may be used in place of a disconnect device.** All Garden Spas™ spas are manufactured and tested to all required codes and standards providing maximum protection against electrical shock. **Spa safety features may not operate properly due to improper wiring and could result in risk of fire, electrical shock, injury, or death. In accordance with all pertinent national, state and local codes and rules, all metal components within the maximum specified distance must be bonded and connected to the ground lug on the exterior of the spa control pack.**

5. Ensure the equipment compartment is in a location where it will not be damaged by water infiltration due to drainage or constant exposure. Cover the equipment compartment with a heavy screen if rodents are a problem. **Damage due to rodents is not covered under warranty.**

Outdoor Spa Installation Guidelines

WARNING: To prevent serious damage to the spa, support surfaces, support structures and/or injury, it is important that the spa foundation be supported by a stable and consistent subsurface.

Spa placement must take into consideration national, state and local building, electrical, plumbing and safety codes, as well as local environmental and geotechnical conditions. Proof of code compliance for the proposed design plans by a qualified licensed contractor, engineer and/or architect prior to installation may be required for issuance of construction permits. The spa must be positioned at the minimum horizontal and vertical distances from all overhead power lines as required by national, state and local codes. Further factors to consider are the desired proximity to the home, environmental exposures such as wind and sun (ultraviolet radiation), location of trees and other vegetation (falling leaves, grass and dirt tracked into spa, roots, shade, etc.), dressing area, landscaping design, lighting, etc. when selecting a location

Since ambient humidity will rise around the spa, materials and components in the surrounding area must be able to withstand elevated humidity levels. Some chemicals for use in sanitation of the spa may corrode metals or degrade other materials in the surrounding area. To avoid potential water damage to the cabinet and frame, the spa must be located on a site away from automatic sprinklers, drains, gutters, etc. and/or sources of frequent external water exposure.

For installations on a deck or elevated surface, the maximum filled weight of the spa and occupants must be determined. The adequacy of the structural support for a spa placed on a deck or an elevated structure must be determined by a licensed structural engineer, architect or contractor depending on local and state requirements. Inadequate structural support may result in structural damage to the spa and/or serious injury or death to occupants. Have the spa deck installed by a knowledgeable contractor to ensure proper support.

Indoor Spa Installation Guidelines

Spa placement must take into consideration national, state and local building, electrical and plumbing codes, local geotechnical conditions affecting the structure of the building, indoor environmental conditions, etc. The surrounding floor surface must have sufficient traction to prevent slips and falls when wet. It is recommended that a floor drain and/or catch basin is present to remove water that accumulates in the area with a capacity up to the total volume of the spa model. Since ambient humidity will rise due to the spa, ample ventilation is required to prevent mold, mildew, rot, fungus, bacteria and other conditions related to high humidity. Materials and components in the surrounding area must be able to withstand elevated humidity levels. Some chemicals for use in sanitation of the spa may corrode metals, or degrade other materials in the surrounding area. A ventilation design incorporating suction, fresh air intake, cross ventilation and/or dehumidifiers may be required and should be determined by an appropriately licensed professional. Ensure ample room is provided for any required servicing and that equipment access panels are not blocked. **Strong foundational support is vital, particularly if a second story site is selected. The adequacy of the structural support for a spa placed on a floor above ground level or an elevated surface must be determined by a licensed structural engineer, architect or contractor depending on local and state requirements. Have the spa deck installed by a knowledgeable contractor to ensure proper support.**

Electrical Wiring

WARNING: The spa must be wired by a certified electrician in accordance with local codes and regulations, as well as with these instructions. Failure to do so will terminate all warranties and invalidate the independent certification company's mark.

1. The Garden Spa requires a 240 VAC dedicated system. The spa must be hard wired to the power supply, with no plug-in connections, extension cords, or sharing of service. For stationary appliances not fitted with means for disconnection from the electrical supply mains having a contact separation in all poles that provide full disconnection under Overvoltage Category III, the disconnection must be incorporated in the fixed wiring of all supply circuits in accordance with the applicable wiring rules.
2. The spa requires 6 (10 mm²) or 8 (8.4 mm²) AWG copper wire is used, depending on the GFCI size. **Do Not Use Aluminum Wire.**
3. The power supply must have a suitable Ground Fault Circuit Interrupter (GFCI), according to Section 422-20 of the National Electrical Code, ANSI/NFPA 70-7987 or other national installation requirement with a residual current device (RCD) having a trip current of not more than 30 mA. This could be used as the shut-off switch, which must be installed in plain view of the spa. This electrical service must

be readily accessible to the spa occupants, but must not be within 5 feet of the spa.

4. Use only non-metallic conduit and fittings when installing power to the spa.
5. After the spa has been positioned, route lines through the knockout on the left or right front corner of the spa.
6. Connect the power to the spa – Connect each color to its respective terminal block location. The Ground (green) wire must be connected to the grounding terminal which is outside of the system box. The Grounding wire must first enter the system box and then access the grounding terminal via a hole on the side of the box, adjacent to the grounding terminal as shown in the picture below.

60 Hz, Garden Spas™ Terminal Options

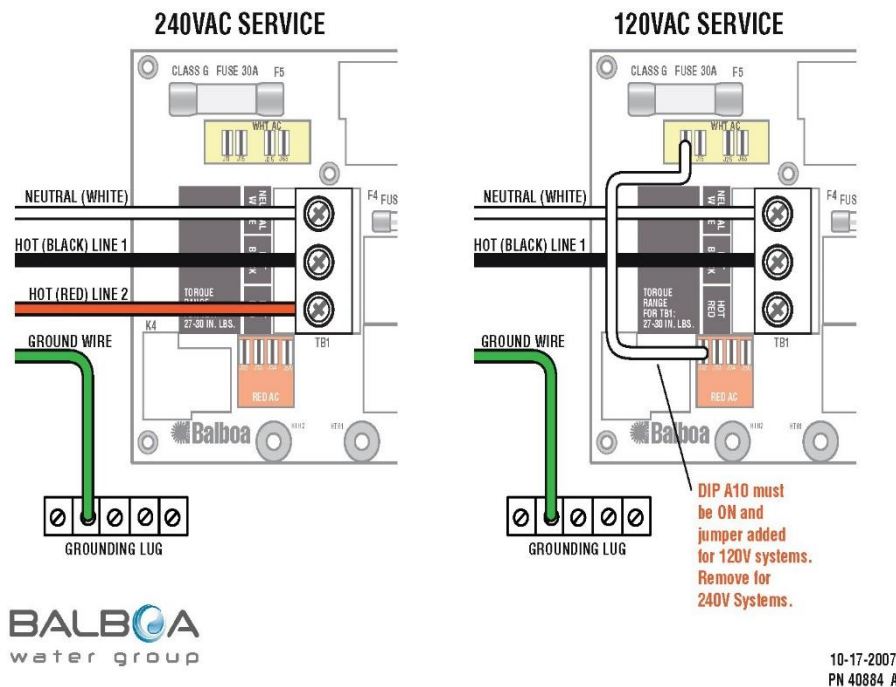

Figure 1. Terminal Connections for 240 V and 120 V Service

Connect each color to its respective terminal block location. The Ground (green) wire must be connected to the grounding terminal which is outside of the System box. The Grounding wire must first enter the system box and then access the grounding terminal via a hole on the side of the box adjacent to the grounding terminal as shown in the picture above.

60 Hz, 240 V Residential GFCI Wiring Schematic

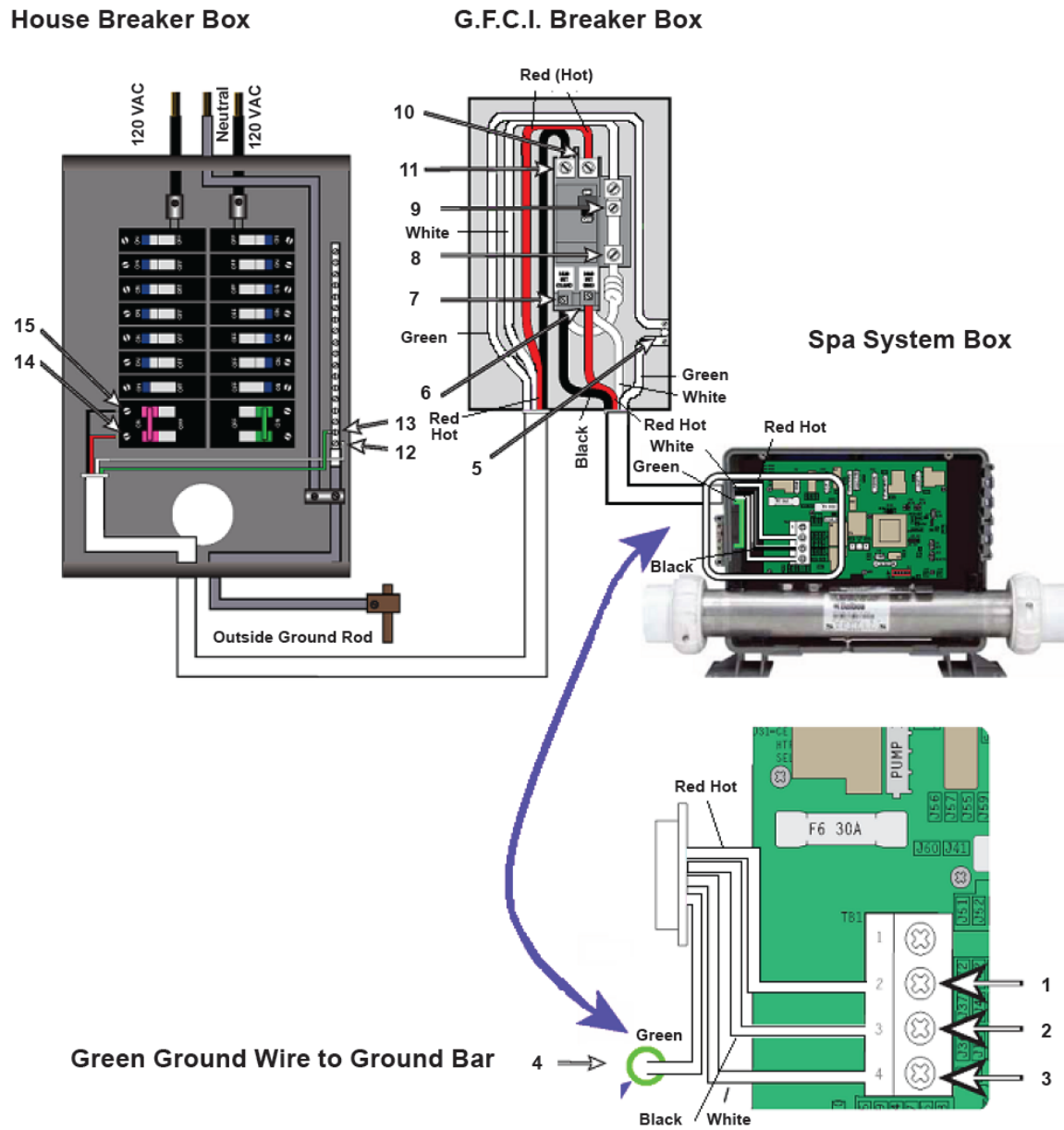

Figure 2. GFCI Wiring Schematic for 60 Hz Systems

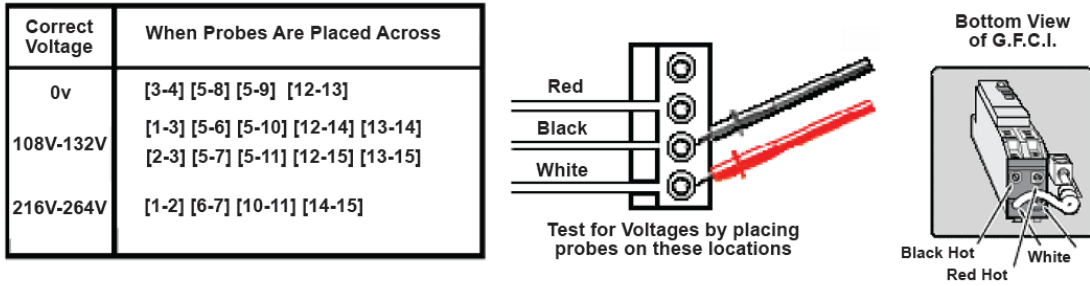

Figure 3. Proper Voltage Readings Across Terminals on House Breaker Box, Spa System Box and GFCI

50 Hz, 240 V Residential 2 Pole RCD Wiring Schematic

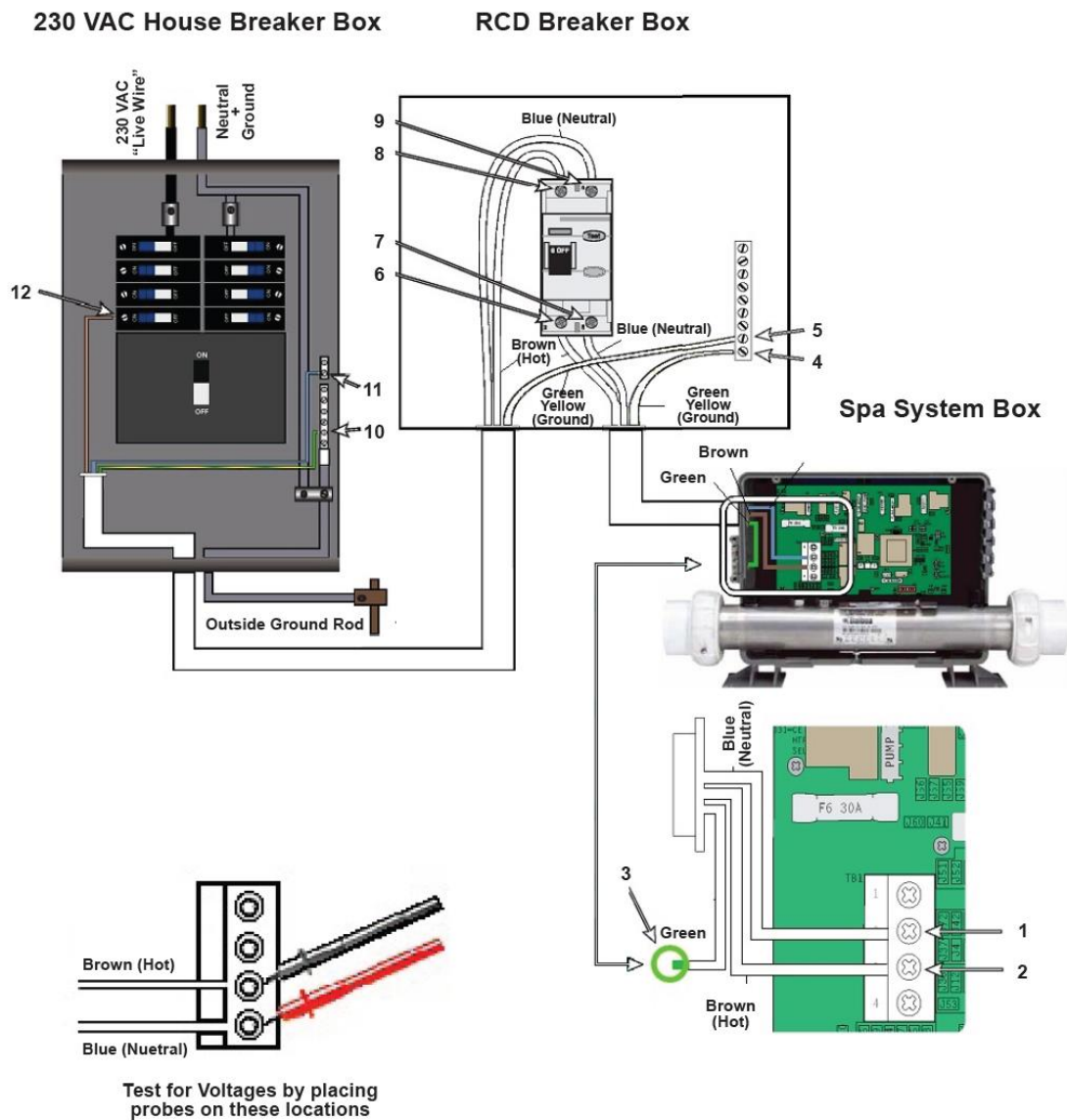

Figure 4. Wiring Schematic for 50 Hz Systems

50 Hz Single, Two and Three Phase Power Wiring

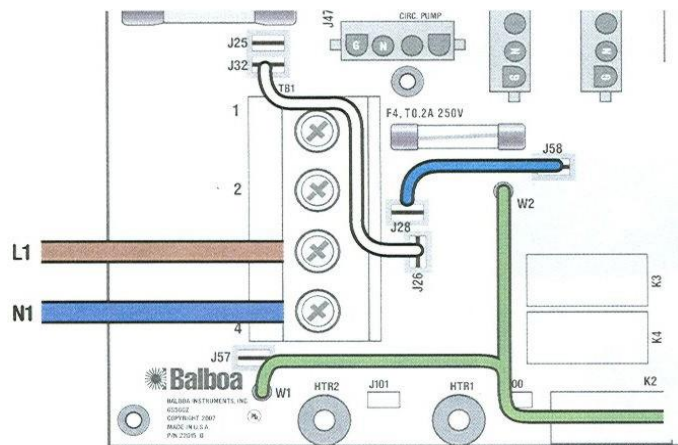

Figure 5. Single Phase Power – TN and TT Electrical Systems

1 X 16 A or 1 X 32 A, 3 Wires (1 Line + 1 Neutral + 1 Protective Earth (Ground))

The protective earth (ground) wire (green– yellow) must be connected to system ground terminal as marked for single phase service. This option is configured and shipped as the default. All equipment (pumps and heater) runs on service line L1.

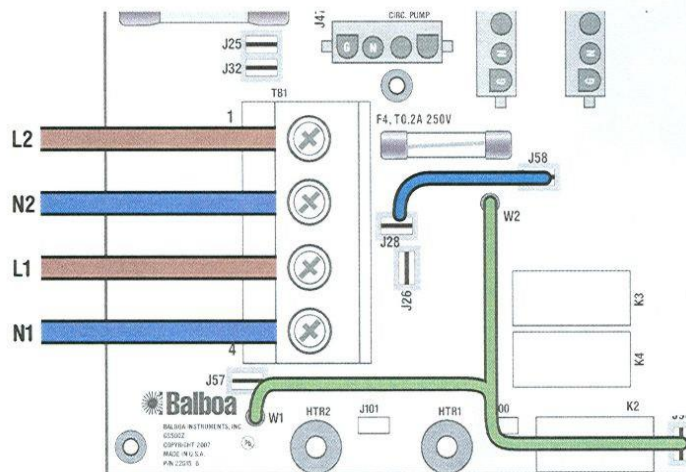

Figure 6. Two Phase Power – TN and TT Electrical Systems

2 x 16 A, 5 Wires (2 Lines + 2 Neutrals + 1 Protective Earth)

The protective earth (ground) wire (green– yellow) must be connected to system ground terminal as marked for dual phase service. The heater runs on service line L1, while all other equipment, such as pumps run on service line L2. Completely remove the white wire from J26 and J32. Please note, J32 and J25 are electrically identical. The white wire may be attached to either terminal before removal.

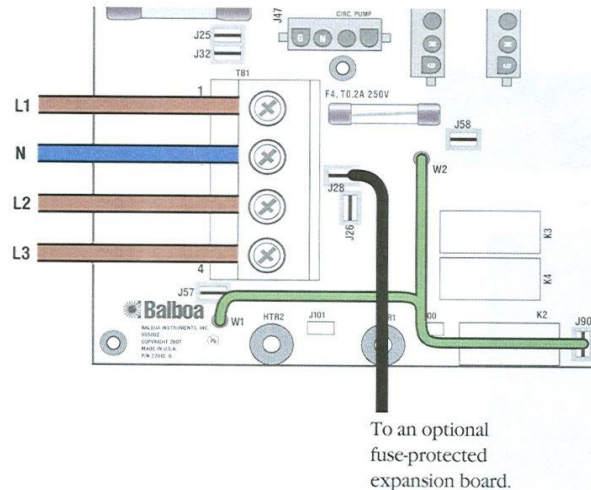

Figure 7. Three Phase Power – TN and TT Electrical Systems
 3 x 16 A, 5 Wires (3 Lines + 1 Neutral + 1 Protective Earth)

The protective earth (ground) wire (green– yellow) must be connected to system ground terminal as marked for dual phase service.

IMPORTANT – Service MUST include a neutral wire, with a line to neutral (L-N) voltage of 230 VAC.

The heater runs on service line L1. All main-board equipment runs on service line L3. Additional equipment, such as expansion boards, run on service line L2. Completely remove the white wire from J26 and J32, or J25 on the control pack board. Completely remove the blue wire from J28 and J58 on the control pack board. If an expansion board is installed, the black wire must connect to J28 (Line L2) only.

Filling the Spa with Water

Perform an inspection of the entire spa prior to filling it with water. Look for and remove any debris in the spa tub and/or in the filter area. Verify that pump plugs are installed on the pumps and all pump unions are tight.

DO NOT fill the spa with hot water straight out of a water heater or tap. This water may be in excess of 140°F (60°C) and will cause damage to the surface and plumbing of the spa and may cause severe burns to individuals. Filling the spa with hot water will void the warranty. Ensure the spa is level before filling.

1. Prepare to fill the tub by removing all debris.
2. Remove the filters from the spa (see Removing, Installing and Cleaning Filters, page 36).

3. Insert the hose in the area where the filter was located as shown in the picture below.



Figure 8. Filling Location in Filter Housing

4. Fill the spa to the bottom of the pillows to cover jets. **DO NOT overfill the spa.** The water level will rise when occupants are inside.
5. With the front panel off, verify there are no leaks at the pump unions. **Pump unions can become loose during shipping. Verify that there are no leaks during filling of the spa.**
6. Replace both filters.

Powering the Spa On

Turn the power to the spa on at the main circuit breaker. Verify that the spa has no warnings or error messages on the panel display. To verify the circulation system is in good working order, perform the following steps:

1. Open all jets to maximum flow position.
2. Press the Jet 1, 2 and 3 buttons to turn the individual pumps on or off.
3. Observe and verify good water flow exists in the jets of each seat.

Upon initial start, one pump will initially come on for 5 minutes and then cycle through each pump sequentially for a one minute duration.

Testing the GFCI for a 60 Hz System

The electrical service panel for the spa must be equipped with a GFCI. To avoid the risk of electrical shock, perform the following safety test before each use of the spa:

1. Check that the power is turned on at the electrical service panel.
2. Turn on the GFCI. If the GFCI stays on, it is functioning properly.

The spa system will automatically trip the GFCI 24 hours after power up. This is a safety feature and cannot be disabled.

DANGER RISK OF ELECTRICAL SHOCK

If the GFCI fails to operate as described, there is a possibility of electric shock if the spa is used. Shut off the power at the main electrical service panel until the source of the problem has been identified and corrected by a licensed electrician or qualified spa technician.

Priming Pumps

1. Turn off power at electrical service panel.
2. Locate and loosen the pump union by turning it counterclockwise one half of one turn.
3. Allow air to escape from the fitting. When a steady stream of water flows from the pump union, close it by turning it clockwise until tight.
4. Turn on power at electrical service panel.
5. Perform one additional check to ensure water is flowing from the jets during the auto purge cycle. If so, continue to Water Preparation. If no water flow is coming from the spa jets, please call your Garden Spas™ dealer for further assistance.

Water Preparation

Proper understanding of the treatment of fresh water prior to use is an important part of maintenance and is one of the key aspects enabling worry free usage. Failure to properly prepare the water can result in substantially decreased life of the components and may void the warranty in severe cases. Please consult your local Garden Spas™ dealer in regards to appropriate start-up and maintenance kits available when purchasing the spa.

TOPSIDE CONTROLLER INSTRUCTIONS



Figure 9. Garden Spas™ Topside Controller Face

Spa Operation

Priming the Pumps

When the spa is first actuated, it will go into Priming mode which is indicated by “Pr”. This Priming mode will last for 5 minutes and then the spa will begin to heat and maintain the water temperature in the Standard Mode. During Priming Mode, press “Jets” button(s) repeatedly and be sure all pumps are free of air.

NOTE: Turning the power off and back on again will initiate a new pump priming session. Sometimes momentarily turning the pump off and on will help it to prime. Do not do this more than 5 times. If the pump(s) will not prime, shut off the power to the spa and call for service.

Important: A pump should not be allowed to run without priming for more than 2 minutes. Under NO circumstances should a pump be allowed to run without priming beyond the end of the 4-5 minute priming mode. Doing so may cause damage to the pump and cause the system to energize the heater and go into an overheat condition.

Exiting Priming Mode

You can manually exit Priming Mode by pressing the Up Arrow (Warm) or Down Arrow (Cool) buttons.



Note that if you do not manually exit the priming mode as described above, the priming mode will be automatically terminated after 4 to 5 minutes. Be sure that the pump(s) have been primed by this time.

Pumps

To ensure proper functionality and component longevity, individual jet pumps must not be cycled on and off more than one time every minute.

Touch the “Jets” button once to activate the pump for the jets. Touch the “Jets” button again to turn off the pumps. If left running, the pumps will automatically turn off after 15 minutes.



Light

Press the “Light” button to turn the light on and off. If left on, the light automatically turns off after 4 Hours.



Temperature Operation

Adjusting the Set Temperature

The start-up temperature is set to 100°F (37°C). The last measured temperature is constantly displayed on the LCD.

NOTE: The last measured spa temperature displayed is current only when the pump has been running for at least 2 minutes.

To display the set temperature, press the “Cool” or “Warm” button once.



To change the set temperature, press the button a second time before the LCD stops flashing. Each press of the “Cool” or “Warm” pad will continue to either lower or raise the set temperature respectively.



Modes of Operation

The mode is changed by pressing the “Warm” or “Cool” button, then pressing the “Light” button.



Standard Mode

Standard Mode is programmed to maintain the desired temperature. Note that the last measured spa temperature is current only when the pump has been running for at least 2 minutes. “St” will be displayed momentarily when you switch into Standard Mode.

Economy Mode

Economy Mode heats the spa to the set temperature only during filter cycles. “Ec” will display solid when temperature is not current, and will alternate when temperature is current.

Sleep Mode

Sleep Mode heats the spa to within 20°F (10°C) of the set temperature only during filter cycles. “SL” will display solid when temperature is not current, and will alternate when temperature is current.

Freeze Protection

If the temperature sensors detect a drop to below 44°F (6.7°C) within the heater, the pump will automatically activate to provide freeze protection. The equipment stays on until 4 minutes after the sensors detect that the spa temperature has risen to 45°F (7.2°C) or higher. In cold climates, an additional freeze sensor may be added to protect against freeze conditions that may not be sensed by the standard sensors. Aux freeze sensor protection acts similarly except with the temperature thresholds determined by the switch and without a 4 minute delay in turnoff. See your dealer for details.

Setting the Filter Cycle

The filter cycle begins 6 minutes after the spa is energized. The second filter cycle begins 12 hours later. Filter duration is programmable 2, 4, 6, or 8 hours for continuous filtration indicated by “FC”. The default filter time is 2 hours.

To program, press “Warm” or “Cool” then Jets.



Press “Warm” or “Cool” to adjust.



Press “Jets” to exit programming.



General Messages

Water Temperature is Unknown

--

After the pump has been running for 2 minutes, the temperature will be displayed.

Possible Freezing Condition

IC

“Ice” – Potential freeze condition detected.

Even when spa is shut down, some equipment will turn on if freeze protection is needed.

No action required. All equipment will automatically activate regardless of spa status. The equipment stays on 4 minutes after the sensors detect that the spa temperature has risen to 45°F (7.2°C) or higher. An optional freeze sensor may be added to protect against extraordinary freeze conditions. Auxiliary freeze sensor protection is advisable in colder climates. See your dealer for details.

Overheat

HH

“Overheat” - The spa has shut down. One of the sensors has detected 118°F (47.8°C) at the heater.

DO NOT ENTER THE WATER. Remove the spa cover and allow water to cool. Once the heater has cooled, reset by pushing any button. If spa does not reset, shut off the power to the spa and call your dealer or service organization.

Overheat

OH

“Overheat” - The spa has shut down. One of the sensors has detected that the spa water is 110°F (43.5°C) at the heater. **DO NOT ENTER THE WATER.** Remove the spa cover and allow water to cool. At 107°F (41.7°C), the spa should automatically reset. If spa does not reset, shut off the power to the spa and call your dealer or service organization.

DO NOT ENTER THE WATER. Remove the spa cover and allow water to cool. Once the heater has cooled, reset by pushing any button. If spa does not reset, shut off the power to the spa and call your dealer or service organization.

The Water Flow is Low

The error code 'LF' is displayed in a stylized, digital font within a light gray rectangular background.

Persistent low flow problems. (Displays on the fifth occurrence of message within 24 hours.) Heater is shut down, but other spa functions continue to run normally.

Follow action required for message. Heating capability of the spa will not reset automatically; you may press any button to reset.

Temperature Difference is Too High

The error code 'HL' is displayed in a stylized, digital font.

A significant difference between temperature sensors has been detected. This could indicate a flow problem.

If the water level is normal, make sure all pumps have been primed. If problem persists, contact your dealer or service organization.

The Heater May Be Dry

The error code 'dr' is displayed in a stylized, digital font.

Possible inadequate water, poor flow, or air bubbles in detected in the heater. Spa is shut down for 15 minutes.

If water level is normal, make sure all pumps have been primed. Press any button to reset. This message will reset within 15 minutes. If problem persists, contact your dealer or service organization.

The Heater May Be Dry

The error code 'd4' is displayed in a stylized, digital font within a light gray rectangular background.

Inadequate water detected in heater. (Displays on third occurrence of “dr” message.) Spa is shut down.

Follow action required for message. Spa will not automatically reset. Press any button to reset manually.

Sensor Related Messages

Sensors Are Out of Sync

SA

Spa is shut down. The sensor that is plugged into the Sensor "A" jack is not working.

Sb

Spa is shut down. The sensor that is plugged into the Sensor "B" jack is not working.

Sn

Sensors are out of balance. If alternating with spa temperature, it may just be a temporary condition. If flashing by itself, spa is shut down.

MAINTAINING THE SPA

Draining the Spa

The spa needs to be drained, cleaned, waxed, and refilled about every six months. More frequent water changes may be necessary if bather load is heavy. A hose bib has been provided to assist in draining the spa.



Figure 10. Hose Bib Opening Instructions

- 1) Turn off the power to the spa. Failing to turn the power off, could cause vital components to be damaged. Do not leave an empty spa exposed for long periods of time in hot, sunny weather.
- 2) Pull tab and then turn counter clockwise till cap is removed.
- 3) Connect the hose to hose bib.
- 4) Pull hose bib out to ensure opening of nozzle/drain plug.
- 5) Check the garden hose end to see if water is flowing. If water is not flowing, check the hose for kinks. Also check to see if the valve is in the full open position.

CAUTION: The chemical content and temperature of the water will cause damage to certain vegetation. Draining the spa onto plants or lawns is not recommended.

When choosing to do this, please remove the spa cover and allow spa to cool for a minimum of 24 hours with the spa turned off.

Pillow Care

Remove and clean the pillows with soapy water and a soft cloth when needed. Use a vinyl conditioner once a month. Remove pillows when doing chemical shock treatment.

Jet Care

Cleaning the jets when draining the spa is recommended.

- 1) Spray jet inserts with a mixture of 1 part vinegar to two parts warm water and let soak for 10 – 15 minutes. Periodically rotate the spinner nozzle to break up residue in the jets.



Rinse the jet inserts with a standard garden hose.



Removing, Installing and Cleaning Filters

These are the steps needed to properly replace the filters. Disposable spa filters should be replaced or non-disposable filters should be cleaned every four months.



- 1) Turn off all power to the spa and remove the filter lid by lifting it out towards you.
- 2) Turn the filter counterclockwise and remove it from the filter well.
- 3) Dispose of the used filter.
- 4) To replace, set screen back into its place and turn clockwise to fasten. DO NOT over-tighten.
- 5) Place the new filter into position and turn clockwise to fasten. DO NOT over-tighten.
- 6) Use of a quality filter soak product is recommended. Please contact your dealer to purchase spa care products.

NOTE: Only use Garden Spas™ approved filters. Using a Non Garden Spas™ approved filter can cause issues with the circulation system and heater and can void warranty coverage. The filter can be upgraded to a 75 Sq. ft. filter. Please see your Garden Spas™ dealer, Part # 06-007-12 (standard) or 06-008-12 (Nature2) option.

WARNING: Power to the spa must be turned off prior to removing the filters. The suction at the filter is extremely strong and can cause injury if there is no filter. NEVER run the spa without the filters properly installed. Injury to person and damage to the equipment can occur. Any damage to equipment due to this circumstance will not be covered under warranty.

Storing or Winterizing the Spa

An emptied spa (without water) must not be exposed to direct sunlight as acrylic shell damage may occur to UV radiation. It is not recommended that the spa be drained

completely during freezing conditions. Leaving the spa full of water with the power on is recommended to keep the tub from freezing. If you decide to drain the spa during freezing conditions, contact your local authorized dealer for assistance.

Contact your Garden Spas™ dealer before refilling a drained spa in freezing temperatures.

WARNING: Damage to the spa caused by freezing is NOT covered under warranty. Please contact your local Garden Spas™ dealer to assist you in winterizing the spa.

Spa Cabinet Care

The spa comes standard with a Grandwood, or faux wood, cabinet. This cabinet requires no maintenance. You may wish to clean the cabinet with mild soap and water from time to time.

Gently wash the cabinet with mild soap and water and allow to dry completely.

Do not apply any solid type finish such as shellac or varnish. After weathering, these types of finishes will crack and/or turn yellow.

Cleaning the Spa Interior

It is important to clean the interior of the spa every time it is drained to help preserve the sheen of the spa's surface. However, it is important that you do not use any abrasive cleaners or strong chemicals. Your Garden Spas™ authorized dealer will be able to supply you with the proper cleaning solution the spa. After cleaning, make sure all residues are removed prior to filling the spa. This will help prevent sudsing and improper chemical balance.

Spa Cover Use, Installation and Care

The spa cover has tie down straps and locking hardware at each corner to securely fasten the cover to the spa cabinet. Proper cover lock installation instructions are included with the cover to ensure compliance with the ASTM F1346-91 safety standard for spa covers.

Never stand or sit on the cover while on or off of the spa and never drag it over abrasive surfaces. Lift cover only by the handles provided.

Dirt acts as an abrasive to the vinyl topcoat, and can also cause wear to folds, seams and stitching. Mildew growing on damp, dirty vinyl will begin to actually rot in the fabric, accelerating failure.

Follow this simple routine for cleaning, prior to application of vinyl.

- 1) Rinse with cool water using a garden hose.

- 2) Spray with a gentle, non-foaming cleaner and wipe clean. Never use laundry detergent, abrasives, alcohols, dish soaps or harsh cleaners. These can actually remove some of the topcoat and cause premature vinyl failure.
- 3) For stubborn dirt, use a non-abrasive sponge.
- 4) Rinse again thoroughly with water and allow to dry.
- 5) Repeat monthly, or as needed.

The vinyl cover is affected by the UV in sunlight. Periodic protection with a liquid protectant will extend the life of the spa cover. The wrong kind of protectant can be more harmful than no protectant at all. Keep any product away from the spa that is labeled “flammable,” that contains any type of oil, or that leaves a waxy coating on the cover.

Chemical Treatment of Water

Water from the tap is fine for showers, bathing and drinking. However, in a contained recirculating system such as in a spa, water must be treated with chemicals. The main purpose of chemical treatment is to keep the water sanitary and to maintain a specific pH balance of the water. Proper pH balance ensures that the water will not cause irritation to the users or harm the spa’s components. Chemical treatment does have its limitations. When water evaporates, chemical residues are left behind.

As the levels of the residues combine with other types of residue, such as body oil and detergents, the water becomes increasingly difficult to maintain. Because of this residual effect, at some point it becomes easier and more cost effective to drain, clean and refill the spa with new water. We recommend that the water be changed at least every six months. At this time you should also clean or replace the filters. If the spa has a frequent and/or heavy bather load, it may be necessary to drain and fill the spa more often. Refer to the section titled “Draining the Spa” for instructions on page 34. **WARNING: Spa damage due to improper chemicals use is not covered under warranty.**

GARDEN SPAS™ WARRANTY

This section is a description of the warranty, what is covered under the Garden Spas™ spa warranty and conditions that can void the warranty. **PLEASE READ THE WARRANTY THOROUGHLY.** Please take a moment to register your warranty. You can register on line at <http://thegardenspaspas.com>, click on support and Click Here to Register your Spa or mail in the warranty registration card attached to this manual. For warranty information outside of the USA and Canada, please refer to your country's Garden Spas™ distributor.

LIFETIME STRUCTURE WARRANTY

Garden Spas™ carry a lifetime structure warranty. The structure is defined as the fiberglass vessel below the exposed material finish. The manufacturer warrants the spa against loss of water due to a defect in the spa structure, for the lifetime of the spa. In the event of a defect in the material and/or workmanship, the spa structure will be repaired or replaced at the discretion of the manufacturer. **THIS WARRANTY IS GIVEN ONLY TO THE ORIGINAL OWNER, AND TERMINATES UPON TRANSFER OF OWNERSHIP. COMMERCIAL APPLICATIONS ARE EXCLUDED FROM THIS AND ALL WARRANTIES.**

If the spa structure is defective and must be replaced, it will be returned to the factory. The original, installed equipment (this includes the frame, skirt, and all equipment) will be reinstalled. If new equipment is desired, there will be additional charges to the customer. If the frame and/or skirt of the spa has been badly damaged, there will be additional charges to the spa owner for repairs or replacement. When a spa needs to be returned to the factory for repair, the cost of one way freight to the company will be at the spa owner's expense. The manufacturer will not pay for removal, installation, cranes, construction, de-construction, or any other cost associated with access, egress, or ingress, of the spa at the customer's home. The manufacturer reserves the right to an on-site inspection by its authorized representative. In the unlikely event a shell or spa must be replaced, all warranties (shell, surface, electrical and plumbing) date back to the original start date of the warranty. The warranty period starts either the day of delivery to the customer or eighteen (18) months from the date of manufacturing, whichever date comes first.

ONE YEAR SURFACE WARRANTY

The spa surface is described as the exposed acrylic material finish. The manufacturer warrants the spa surface to be free from defects in the material and workmanship, such as blistering, cracking, or delaminating, this does not cover micro-crazing, under normal use and maintenance for a period of one year from the original date of the warranty. The warranty period starts either the day of delivery to the customer or eighteen (18) month from the date of manufacturing, whichever date comes first. **THIS WARRANTY IS ONLY AVAILABLE TO THE ORIGINAL OWNER, AND TERMINATES UPON TRANSFER OF**

OWNERSHIP. COMMERCIAL APPLICATIONS ARE EXCLUDED FROM THIS AND ALL WARRANTIES.

The spa must be set on a level solid surface that is sufficient to support the entire length and width of the spa. Standard building practices must be followed. Damage caused by failure to have a leveled and supported foundation under the spa is not covered under warranty. The manufacturer does not warrant problems associated with prolonged exposure to the sun and/or use of any sanitization or ozone system not approved by the manufacturer. Damage to the spa surface caused by leaving the spa uncovered and empty of water with direct sunlight exposure will terminate this warranty. Any alteration to any system, either electrical, plumbing, or mechanical, or over use of chemicals, or any other problems caused by external source are not covered under warranty. Other exclusions may apply.

Normally problems associated with material and workmanship can and will be repaired. If the spa surface is repaired, the repair is limited to the affected area only, and there is no guarantee against discoloration or fading. The decision to repair will be made by the manufacturer and its field representative after a review of the facts, pictures, or any other data presented by the dealer or customer. In all cases, pictures of the affected area and foundation of the spa must be provided before any decisions to repair or replace can be made. In the unlikely event a shell or spa must be replaced, all warranties (shell, surface, electrical and plumbing) date back to the original date of installation. If it is determined that the surface is to be replaced, the same conditions and terms as outlined in the shell warranty will apply.

ONE YEAR ELECTRICAL WARRANTY

(i.e., pumps, equipment packs, heaters, topside, etc.)

The MANUFACTURER warrants all electrical equipment to be free from defect in material and workmanship for one year from the original start date of the warranty. The warranty period starts either the day of delivery to the customer or eighteen (18) month from the date of manufacturing, whichever date comes first. **THIS WARRANTY IS GIVEN ONLY TO THE ORIGINAL CONSUMER AND TERMINATES UPON TRANSFER OF OWNERSHIP. COMMERCIAL APPLICATIONS ARE EXCLUDED FROM THIS AND ALL WARRANTIES.**

The stereo, speakers, L.E.D. lighting, and Ozone are not included in this warranty but are covered under a separate warranty. Damage caused by acts of nature, poor water chemistry, and/or improper maintenance will not be covered under this warranty. Alterations or replacements of components installed in the spa that are not purchased and/or approved by the MANUFACTURER, including incorrect wiring, will terminate the complete spa warranty.

ONE YEAR PLUMBING WARRANTY

The plumbing is described as all piping, jet bodies, valve bodies and air controls. The manufacturer warrants all plumbing for a period of one year from the original start date of the warranty. The warranty period starts either the day of delivery to the customer or eighteen (18) month from the date of manufacturing, whichever date comes first. **THIS WARRANTY IS GIVEN ONLY TO THE ORIGINAL OWNER, AND TERMINATES UPON TRANSFER OF OWNERSHIP. COMMERCIAL APPLICATIONS ARE EXCLUDED FROM THIS AND ALL WARRANTIES.** Jet internals, valve handles, and other such items are regular maintenance items. They are covered for the item only, labor is not covered for these items. Damage caused by acts of nature, poor water chemistry, and/or improper maintenance will not be covered under this warranty.

ONE YEAR CABINET WARRANTY

The spa cabinet is described as the outer material encasing the spa structure. The manufacturer warrants it to be free from defects in material and/or workmanship for a period of one year from the original start date of the warranty. The warranty period starts either the day of delivery to the customer or eighteen (18) month from the date of manufacturing, whichever date comes first. **THIS WARRANTY IS GIVEN ONLY TO THE ORIGINAL OWNER, AND TERMINATES UPON TRANSFER OR OWNERSHIP.**

COMMERCIAL APPLICATIONS ARE EXCLUDED FROM THIS AND ALL WARRANTIES. This warranty does not cover normal darkening, staining, or aging. The spa cabinet requires care and maintenance by the consumer. Damage caused by acts of nature, poor water chemistry, and/ or improper maintenance will not be covered under this warranty.

OTHER ITEMS NOT COVERED IN THIS WARRANTY

Some items are not covered in this warranty. These items either have a different warranty, or are warranted through the manufacturer of that item.

STEREO AND STEREO COMPONENTS

The stereo and stereo components, including speakers, Bluetooth®, subwoofer, stereo power supply, wire harness and remote control are covered for 30 days from the original start date of the warranty. The warranty period starts either the day of delivery to the customer or eighteen (18) month from the date of manufacturing, whichever date comes first. Please note: Warranty coverage for both parts and labor is covered for 30 days only. Parts, not labor, will be covered for one year from date of installation. This warranty does not cover damage to a stereo or stereo component from abuse, poor reception, or damage caused by putting a wet CD into the stereo. If a stereo is replaced under this warranty, the manufacturer reserves the right to replace the unit with another like unit, but not necessarily the same stereo manufacturer. No spa will be replaced for a failed stereo. The stereo does not affect the performance of the spa.

NOTE: For all operating instructions see the stereo manufacturer's owner's manual included with the spa.

OZONATOR

The ozonator is covered for one year from the original start date of the warranty. The warranty period starts either the day of delivery to the customer or eighteen (18) month from the date of manufacturing, whichever date comes first.

SPA COVER

The spa cover manufacturer warrants the spa cover skin for one year from the original start date of the warranty. The warranty period starts either the day of delivery to the customer or eighteen (18) month from the date of manufacturing whichever date comes first.

Do not return the spa cover to the manufacturer. This will delay the replacement or repair of the cover. The spa manufacturer is not responsible for lost covers.

LIGHTING

The lighting is guaranteed to work upon delivery. There is no warranty covering the lighting.

PERFORMANCE

In the event of any defect covered by this LIMITED warranty, a May Manufacturing LLC, authorized agent will correct such defect within the terms and conditions contained herein. There will be no charge for parts or labor within the above terms. However, travel charges that occur will not be covered under terms and conditions by the warranty. If it is determined by May Manufacturing LLC that the repair of the product is not feasible, a replacement spa equal to the value of the original purchase price will be provided. Cost for removal of the defective spa and delivery and installation of the replacement spa is the responsibility of the homeowner and will not under any circumstances be covered by Artesian Spas™ (May Manufacturing, LLC.)

LIMITATIONS

This warranty is void if this Garden Spa™ spa has been subjected to alteration, misuse, or repairs have been performed by anyone other than an authorized agent of May Manufacturing LLC. Misuse or abuse is defined as: use of the spa in a nonresidential application, water temperature outside the range of 32 degrees F to 110 degrees F, damage caused by clogged or dirty filter cartridges, damage to the spa from an absence of a hard cover, damage to components from improper pH, use of any type of acid, or from chemical imbalance. ACTS OF NATURE are not covered under this warranty.

NOTE: Warranty on 50 Hz spas excludes labor.

(Outside US and Canada)

DISCLAIMER

May Manufacturing LLC. or its agents shall not be liable for any injury, cost or other damage, whether incidental or consequential, arising out of any defect covered by the LIMITED WARRANTY. The liability of Artesian Spas™ (May Manufacturing, LLC.) under this LIMITED WARRANTY shall not exceed the original amount paid for the spa.

LEGAL REMEDIES

This LIMITED WARRANTY gives specific rights, and other rights that may apply and will vary from state to state.

WHAT IS NOT COVERED UNDER THE WARRANTY

The following is a general overview of non-warranty items and work. This is not an all-inclusive list.

Diagnosis of Spa Problems

Fuses

Light Bulbs of Any Kind

Removing a Spa from a Structure

Pillows

Filters

Chemical Misuse/ Damage

Filter Lids

Any Part Not Purchased from Garden Spas™

Jet Inserts Valve Handles Pump Seals

Draining and filling the Spa

Acts of Nature Travel Charges Cabinet Screws Incorrect Wiring Shipping Charges

By Using Garden Spas™ Parts

THIS WARRANTY IS GIVEN ONLY TO THE ORIGINAL OWNER, AND TERMINATES UPON TRANSFER OF OWNERSHIP. COMMERCIAL APPLICATIONS ARE EXCLUDED FROM THIS AND ALL WARRANTIES.

Any alteration of the spa that has not been pre-authorized by the manufacturer will void all warranties. If the manufacturer approves an alteration, verify that this alteration is covered under warranty. Damage caused by moving a spa that is blocked in or that has been recessed, along with additional charges for labor, is not covered by this warranty.

Please do not send products or other correspondence to the address below.

Place
Stamp
Here

MAY MANUFACTURING,LLC
Attn: Customer Care Department
4720 N. Lamb Blvd.
Las Vegas, NV 89115

SPA & WARRANTY REGISTRATION

Activate Product Warranty & Download Owner's Manuals

Please activate your warranty and register your spa by mailing in this reply card, or go online at www.TheGardenSpas.com and click SUPPORT then "click Here to Register Your Spa".

(Serial # is required below and can be located on the bottom kick plate of the spa, or can be found within the cabinet next to the equipment on a white placard attached to the frame.)

Name _____ Email _____

Address _____

City _____ State _____ Zip _____

Phone Number _____

Date of Installation _____ Spa Serial Number (required) _____

Spa Model _____

Your Dealers Name and Location _____

Optional Questions:

What other spa brands did you consider buying? _____

How many people are in your household? _____

What is your age bracket? 25-30 31-40 41-50 51-60 61-70 71+

What is your reason for purchasing a spa? Health Benefits Stress Relief Relaxation

Other: _____



4720 N. Lamb Blvd.
Las Vegas, Nevada 89115
www.TheGardenSpas.com