



ARTESIAN SPAS™
EXPERIENCE THE ULTIMATE

Island Spas ELITE™

OWNER'S MANUAL





ARTESIAN SPAS™
EXPERIENCE THE ULTIMATE

CERTIFICATE OF AUTHENTICITY

Thank you for your purchase. This certificate hereby verifies that the spa you have purchased from an Artesian Spas (May Manufacturing, LLC) authorized dealer is authentic, brand new and original. The spa has been crafted and built in the U.S.A in accordance with industry quality standards.

WARRANTY REGISTRATION

Please activate your warranty and register your spa at www.ArtesianSpas.com click on owner login or mail the registration card in the back of the owner's manual.

Spa Serial # _____

Spa Model: _____

Date Purchased: _____

Installation Date: _____

Dealer Name: _____

Telephone #: _____



TABLE OF CONTENTS

Certificate of Authenticity	
Important Safety Instructions	1
Electrical Requirements and Installation	6
Codes and Compliance.....	6
Electrical Wiring.....	6
60 Hz GFCI Wiring Schematic.....	8
50 Hz Residential Wiring Schematic.....	9
Spa Start Up	10
Selecting a Location.....	10
Inspection.....	11
Filling the Spa with Water.....	11
Turning the Power On.....	12
Testing the GFCI Breaker.....	12
Verifying Water Circulation.....	12
Priming the Pump.....	13
Water Preparation.....	13
Topside Controller Instructions	14
The Main Screen	15
Spa Operation	16
Temperature Operation	19
Settings Screen	20
Temp Range.....	21
Heat Mode.....	21
Ready Mode.....	21
Rest Mode.....	21
Time of Day.....	22
Setting Filter Cycle.....	24
Invert Display.....	28
Restricting Operations (LOCK).....	28
Hold.....	30
Utilities.....	31
Preference.....	31
Temp Display.....	32
Time Display.....	32
Reminder.....	32
Dolphin Not Used.....	33
Color.....	33
Language.....	33

TABLE OF CONTENTS

General Messages.....	34
Heater Related Messages.....	35
Sensor-Related Messages.....	36
Miscellaneous Messages.....	36
System Related Messages.....	37
Reminder Messages.....	38
Direct Flow Control Panel.....	39
Maintaining Your Spa.....	40
Draining Your Spa.....	40
Pillow Care.....	40
Jet Care.....	41
Removing, Installing and Cleaning Filters.....	42
Winterizing Your Spa.....	43
Spa Cabinet Care.....	43
Cleaning Your Spa Interior.....	43
Cover Care.....	44
Chemical Treatment of Water.....	44
Artesian Spas Island Elite Warranty.....	46
Artesian Spas Island Elite Parts List & Diagram...	52

IMPORTANT SAFETY INSTRUCTIONS

PLEASE TAKE THE TIME TO READ ALL OF THESE WARNINGS AND CAUTIONS PRIOR TO USING YOUR SPA.

PLEASE, be a responsible spa owner. When installing and using this spa, always adhere to basic safety precautions. Be sure to list emergency telephone numbers at the telephone nearest the spa, including physician, hospital, ambulance, police, and the fire department. Be certain to explain safety precautions to all new or occasional users of your spa. Remember, they may not be aware of the possible risks associated with the spa water temperature. Have at least one family member learn CPR (cardiopulmonary resuscitation). **IT COULD SAVE A LIFE!**

READ AND FOLLOW ALL INSTRUCTIONS

1. **WARNING** - To reduce the risk of injury, do not permit children to use this product unless they are closely supervised at all times.

2. A wire connector is provided on this unit to connect a minimum 8 AWG (8.4 mm) solid copper conductor between this unit and any metal equipment, metal enclosures of electrical equipment, metal water pipe, or conduit within 5 feet (1.5 m) of the unit.

3. For cord connected/convertible units. **DANGER - Risk of Injury -**

a) Replace damaged cord immediately.

b) Do not bury cord.

c) Connect to a grounded, grounding type receptacle only.

4. **DANGER - Risk of Accidental Drowning** - Extreme caution must be exercised to prevent unauthorized access by children. To avoid accidents, ensure that children cannot use this spa unless they are supervised at all times.

5. **DANGER - Risk of Injury** - The suction fittings in this area are sized to match the specific water flow created by the pump. Should the need arise to replace the suction fittings or the pump, be sure the flow rates are compatible.

Never operate spa if the suction fittings are broken or missing. Never replace a suction fitting with one rated less than the flow rate marked on the original suction fitting.

6. **DANGER - Risk of Electrical Shock** - Install at least 5 feet (1.5 m) from all metal surfaces. As an alternative, a spa may be within 5 feet of metal surfaces if each metal surface is permanently connected by a minimum 8 AWG (8.4 mm) solid copper conductor to the wire connector on the terminal box that is provided for this purpose.

IMPORTANT SAFETY INSTRUCTIONS

7. **DANGER - Risk of Electric Shock** - Do not permit any electrical appliance such as a light, telephone, radio, or television, within 5 feet (1.5m) of a spa.

8. **WARNING - To reduce the risk of injury:**

a) The water in a spa should never exceed 40°C (104°F). Water temperatures between 38°C (100°F) and 40°C are considered safe for a healthy adult. Lower water temperatures are recommended for young children and when spa use exceeds 10 minutes.

b) Since excessive water temperatures have a high potential for causing fetal damage during the early months of pregnancy, pregnant or possibly pregnant women should limit spa water temperatures to 38°C (100°F).

c) Before entering a spa, the user should measure the water temperature with an accurate thermometer since the tolerance of water temperature-regulating devices varies.

d) The use of alcohol, drugs, or medication before or during spa use may lead to unconsciousness with the possibility of drowning.

e) Obese persons and persons with a history of heart disease, low or high blood pressure, circulatory system problems, or diabetes should consult a physician before using a spa.

f) Persons using medication should consult a physician before using a spa since some medication may induce drowsiness while other medication may affect heart rate, blood pressure, and circulation.

SAVE THESE INSTRUCTIONS

EQUIPMENT ASSEMBLIES

An equipment assembly shall be additionally provided with the following important safety instructions

1. **WARNING** - Risk of Accidental Drowning. Extreme caution must be exercised to prevent unauthorized access by children. To avoid accidents, ensure that children cannot use a spa or hot tub unless they are closely supervised at all times.

2. **DANGER** - To reduce the risk of drowning from hair and body entrapment, install a suction fitting(s) with a marked flow rate that equals or exceeds the flow rate marked on the equipment assembly.

3. **DANGER** - To reduce the risk of injury, do not remove the suction fittings. Never operate a spa or hot tub if the suction fittings are broken or missing. Never replace a suction fitting with one rated less than the flow rate marked on the equipment assembly.

IMPORTANT SAFETY INSTRUCTIONS

4. **DANGER**- Risk of Electric Shock. Do not permit any electric appliance, such as a light, telephone, radio, or television, within 5 feet (1.5m) of a spa or hot tub.

5. **WARNING** - Risk of Electric Shock. Install at least 5 feet (1.5m) from inside wall of hot tub or spa using nonmetallic plumbing.

6. **WARNING** - To reduce the risk of injury:

a) The water in a spa should never exceed 40°C (104°F) Water temperatures between 38°C (100°F) and 40°C are considered safe for a healthy adult. Lower water temperatures are recommended for young children and when spa use exceeds 10 minutes.

b) Since excessive water temperatures have a high potential for causing fetal damage during the early months of pregnancy, pregnant or possibly pregnant women should limit spa water temperatures to 38°C (100°F).

c) Before entering a spa or hot tub, the user should measure the water temperature since the tolerance of water temperature regulating devices varies.

d) The use of alcohol, drugs or medication before or during spa or hot tub use may lead to unconsciousness with the possibility of drowning.

e) Obese persons and persons with a history of heart disease, low or high blood pressure, circulatory system problems, or diabetes should consult a physician before using a spa.

f) Persons using medication should consult a physician before using a spa or hot tub since some medication may induce drowsiness while other medication may affect heart rate, blood pressure, and circulation.

7. For equipment assemblies with a gas heater

WARNING - Risk of suffocation. This equipment assembly uses a gas heater and is intended for outdoor use only unless proper ventilation can be provided for an indoor installation.

8. For equipment assemblies with a blower

WARNING - Install blower no less than 1 foot (305mm) above the maximum water level to prevent water from contacting electrical equipment.

SAVE THESE INSTRUCTIONS

IMPORTANT SAFETY INSTRUCTIONS

Marking for equipment assemblies

 WARNING
REDUCE THE RISK OF ELECTROCUTION <ol style="list-style-type: none">1. Install at least 5 feet from water using nonmetallic plumbing.2. Do not install under spa skirt or within an enclosure that would restrict ventilation.3. If blower is included, install at least 1 foot above maximum water level.
REDUCE THE RISK OF CHILD DROWING <ol style="list-style-type: none">1. Supervise children at all times.2. Attach spa cover after each use.3. Install a suction guard with marked flow rate no less than ____ GPM to avoid hair and body entrapment.
REDUCE THE RISK OF OVERHEATING <ol style="list-style-type: none">1. Check with a doctor before use if pregnant, diabetic, in poor health, or under medical care.2. Exit immediately if uncomfortable, dizzy or sleepy. Spa heat can cause hyperthermia and unconsciousness.3. Spa heat in conjunction with alcohol, drugs, or medication can cause unconsciousness.
WHEN PREGNANT , soaking in hot water for long periods can harm your fetus. Measure water temperature before entering. <ol style="list-style-type: none">1. Do not enter spa if water is hotter than 100°F (38°C).2. Do not stay in spa for longer than 10 minutes.

AUDIO COMPONENT WARNINGS

Spas equipped with the Audio system should follow these guidelines for safety:

1. **CAUTION** - Risk of Electrical Shock - Do not leave compartment door open.
2. **CAUTION** - Risk of Electrical Shock - Replace components only with identical components.
3. Do not operate the audio controls while inside the spa.
4. **WARNING - Prevent Electrocution** - Do not connect any auxiliary components (for example cable, additional speakers, headphones, additional audio/video components, etc.) to the system.
5. These units are not provided with an outdoor antennae; when provided, it should be installed in accordance with Article 810 of the National Electrical Code, ANSI/NFPA 70.
6. Do not service this product yourself as opening or removing covers may expose you to dangerous voltage or other risk of injury. Refer all servicing to qualified service personnel.

IMPORTANT SAFETY INSTRUCTIONS

7. When the power supply connections or power supply cord(s) are damaged; if water is entering the audio/video compartment or any electrical equipment compartment area; if the protective shields or barriers are showing signs of deterioration; or if there are signs of other potential damage to the unit, turn off the unit and refer serviceing to qualified service personnel.

8. This unit should be subjected to periodic routine maintenance (for example, once every 3 months) to make sure that the unit is operating properly.

KEEP THESE SAFETY INSTRUCTIONS IN A CONVENIENT AND READILY ACCESSIBLE LOCATION!!

ELECTRICAL REQUIREMENTS AND INSTALLATION

The following information is provided for hooking up electrical supply to your new spa. A qualified, licensed, electrician must perform this work. Failure to follow these instructions will terminate all warranty coverage and can cause serious injury or death.

Codes and Compliance

North American 60 Hz	5X/6X JETS 3/4 PUMPS
Voltage	240 VAC
Max Current Draw	48 A
Number of Wires	4
GFCI	60 A

Your export 50 Hz Artesian spa is preset out of factory to run 230 V 3wires 30 amp max input. This product must always be connected to residual current device (RCD) having a trip current of not more than 30 mA.

Electrical Wiring

WARNING: Your spa must be wired by a certified electrician and according to these instructions. Failure to do so will terminate all warranties and all listings from the independent listing facility.

- 1) The Island Elite Spa requires a 240 VAC dedicated system. The spa must be hard wired to the power supply, with no plug-in connections, extension cords, or sharing of service.
- 2) The spa requires that you run 6 (10 mm²) or 8 (8.4 mm²) AWG copper wire, depending on the GFCI size. Do Not Use Aluminum Wire.
- 3) The power supply must have a suitable Ground Fault Circuit Interrupter (GFCI), according to Section 422-20 of the National Electrical Code, ANSI/NFPA 70-7987 or other national installation requirement with a residual current device (RCD) having a trip current of not more than 30 mA. This could be used as the shut-off switch, which must be installed in plain view of the spa. This electrical service must be readily accessible to the spa occupants, but must not be within 5 feet of the spa.
- 4) Use only non-metallic conduit and fittings when installing power to the spa.
- 5) After your spa has been positioned, route lines through the knockout on the left or right front corner of the spa.

6) Connect the power to the spa

Connect each color to its respective terminal block location. The Ground (green) wire must be connected to the grounding terminal which is outside of the System box. The Grounding wire must first enter the system box and then access the grounding terminal via a hole on the side of the box adjacent to the grounding terminal as shown in the picture above.

60 Hz GFCI WIRING SCHEMATIC

240 Volt Residential Wiring Schematic with G.F.C.I.

House Breaker Box

G.F.C.I. Breaker Box

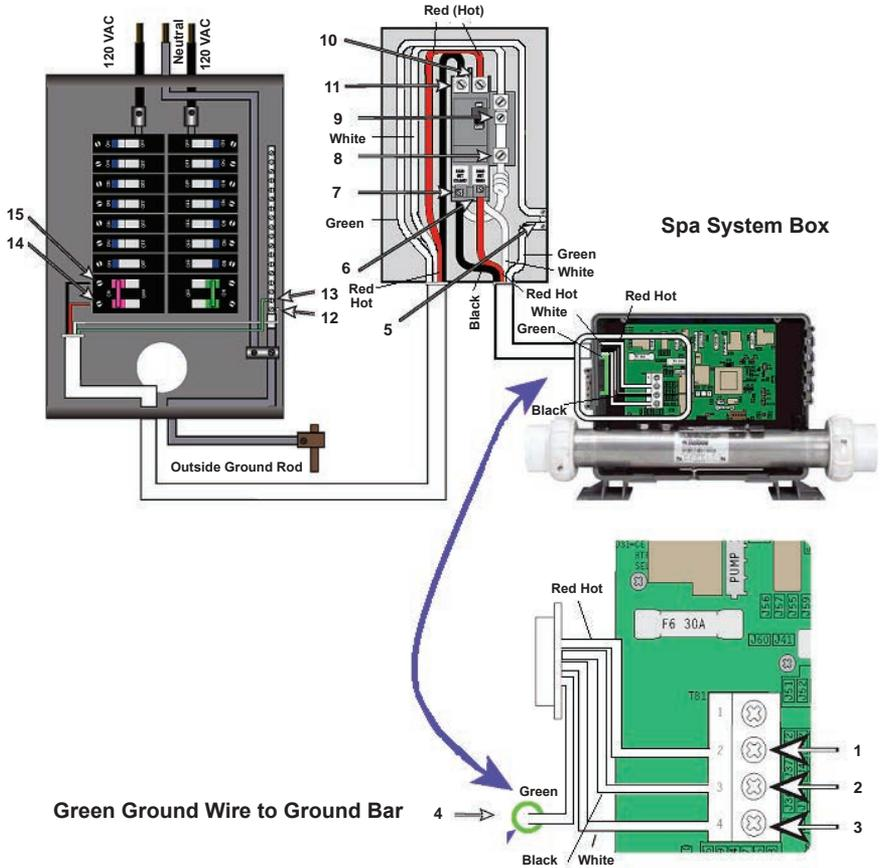

Correct Voltage	When Probes Are Placed Across
0v	[3-4] [5-8] [5-9] [12-13]
108 V-132 V	[1-3] [5-6] [5-10] [12-14] [13-14] [2-3] [5-7] [5-11] [12-15] [13-15]
216 V-264 V	[1-2] [6-7] [10-11] [14-15]

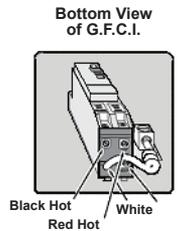
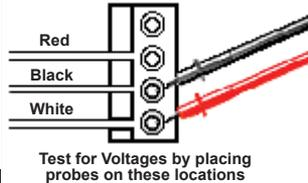

50 Hz RESIDENTIAL WIRING SCHEMATIC

230 Volt/50 Hz Residential Wiring Schematic with 2 Pole RCD Breaker Box
 230 VAC House Breaker Box RCD Breaker Box

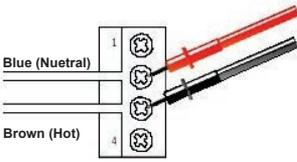
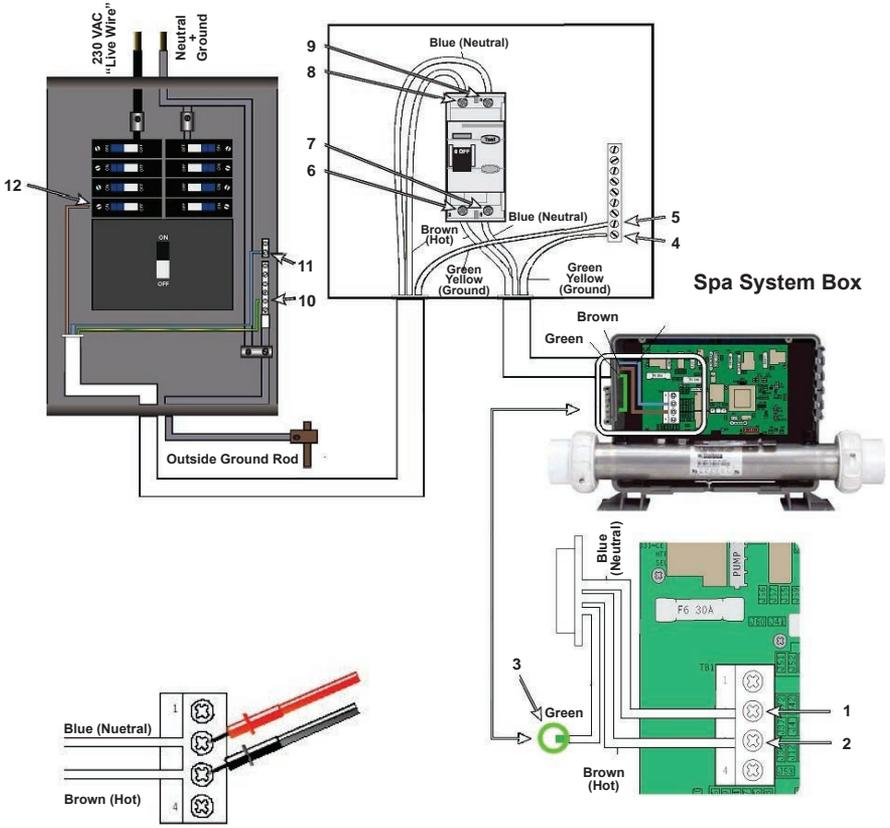

Test for Voltages by placing probes on these locations

SPA START-UP

Please read each step of the Start-up section prior to doing the step.

SELECTING A LOCATION

In preparation for installing your new Artesian spa, you should ensure that your chosen location meets some minimum guidelines:

1) Place your spa on a surface that is large enough for the entire spa to fit. Consider the space needed to easily access equipment compartments and circuit breakers. Remember, all electronics must be kept dry.

2) The spa must be on a solid, level foundation. Recommended: 4 in cement slab that has cured for at least 72 hours. Your warranty will be voided if the spa is not properly installed. Structural damage due to an improper foundation is not covered under warranty.

3) To avoid potential water damage to the skirt and frame, your spa should be placed on a site where it will not be in the way of water sprinklers.

(4) **OUTDOOR SPAS:** Consider building codes, electrical and plumbing codes, desired proximity to house, wind and sun exposure, location of trees (falling leaves, shade), dressing area, landscaping and lighting when selecting a location.

5) **INDOOR SPAS:** Floor surface must have traction to prevent slipping when wet. A floor drain is optimum. As room humidity will increase because of the spa, provide ample ventilation to prevent dry rot, mildew and mold. Use materials that will withstand humidity. There may be a need for cross-ventilation fans and/or dehumidifiers. The spa chemicals may corrode some household metals. Provide ample room if servicing should be needed. Strong foundational support is vital, particularly if a second-story site is selected.

6) Ensure the equipment compartment is in a location where it will not be damaged by water drainage. Cover the equipment compartment with a heavy screen if rodents are a problem. Damage due to rodents is not covered under warranty.

7) Have the spa deck installed by a knowledgeable contractor to ensure proper support.

8). If the spa is placed on the ground, even for a short period of time, it must be supported by stones that are at least 2 inches thick and 12 inches square. A solid foundation is recommended as soon as possible.

SPA START-UP

INSPECTION

You will want to inspect your spa, prior to filling it up with water. Look for and remove any debris in the spa tub and in the filter. Verify that pump are installed on the pumps and the pump unions are tight.

FILLING THE SPA WITH WATER

NOTE: DO NOT fill your spa with hot water straight out of your water heater or tap. This water may be as hot as 180 degrees F and will cause damage to the surface and plumbing of the spa. This will void your warranty. Level the spa before filling.

- 1) Prepare to fill the tub by removing all debris.
- 2) Remove the filters from your spa (see Removing, Installing and Cleaning Filters, page 42.)
- 3) Place your garden hose in the center of the filter as shown in the picture below.
- 4) Fill the tub from the circulation pump line until water level is above the foot-well.

NOTE: This will purge all the air out of the circulation pump. An air lock can cause damage to the circulation pump and is not covered under warranty.



SPA START-UP

FILLING THE SPA WITH WATER

5) Once the water level is filled over the foot-well, you can pull the hose out of the filter line and continue filling the spa from the filter well.

6) Fill the spa to the bottom of the pillows.

NOTE: DO NOT OVER-FILL YOUR TUB!

7) With the front panel off, verify there are no leaks at the pump union.

NOTE: Pump unions can become loose during shipping. Verify that there are no leaks during filling of the spa.

8) Reinstall the filters.

TURNING THE POWER ON

Turn the power to the spa on at the main circuit breaker. Verify that your spa has no messages. Verify that there is good water circulation in the spa. The pumps will come on in cycles, for 1 minute each cycle.

TESTING THE GFCI BREAKER

NOTE: The electrical service panel for your spa should be equipped with a GFCI breaker. To avoid the risk of electrical shock, perform the following safety test before each use of your spa.

1) Make sure the power is turned on at the electrical service panel.

2) Turn on the GFCI breaker. If the breaker stays on, it is functioning properly.

NOTE: The spa system will automatically trip the GFCI 24 hours after power up. This is a safety feature and can not be disabled.

VERIFYING WATER CIRCULATION

1) Open all the jets.

2) Press the Pump 1 key to turn the pumps on or off.

3) Make sure each seat has water flow. Note: On certain spas there is a diverter valve. Verify where the diverter valve is located.

SPA START-UP

NOTE: When power is turned on, your spa is automatically programmed to start circulating water through the circulation pump. Each pump and/or blower will come on consecutively for approximately 1 minute to automatically purge the system. Adjust your temperature by pressing the up button on your touch pad until the desired temperature is displayed. This setting will allow your spa to heat to the set temperature.

DANGER: RISK OF ELECTRICAL SHOCK

If the GFCI breaker fails to operate as described, there is a possibility of an electrical shock if the spa is used. Shut off the power at the main electrical service panel until the source of the problem has been identified and corrected by a licensed electrician or qualified spa technician.

PRIMING THE PUMP

- 1) Turn off power at electrical service panel.
- 2) Locate and loosen one of the pump union on each pump by turning it counterclockwise one half of one turn.
- 3) Allow air to escape from fittings. When a steady stream of water flows from the pump union, close it by turning it clockwise until tight.
- 4) Turn on power at electrical service panel.
- 5) Check once more to make sure that water is flowing from the jets during auto purge. If so, continue. If no water is coming from your spa jets, please call your Artesian dealer for further assistance.

CAUTION: *If water is not noticeably coming from your spa jets during the automatic purge, turn on the high speed pump. If water is still not coming from the jets, the pump needs to be manually primed, following the steps below.*

WATER PREPARATION

NOTE: Before putting your new spa into operation, understand that preparing your new water is an important part of maintenance. Failure to properly prepare your water can result in substantially decreasing the life of the components and may void your warranty in severe cases. Your Artesian dealer should have a start-up and maintenance kit available for you when you receive your spa.

TOPSIDE CONTROLLER INSTRUCTIONS



TOPSIDE CONTROLLER

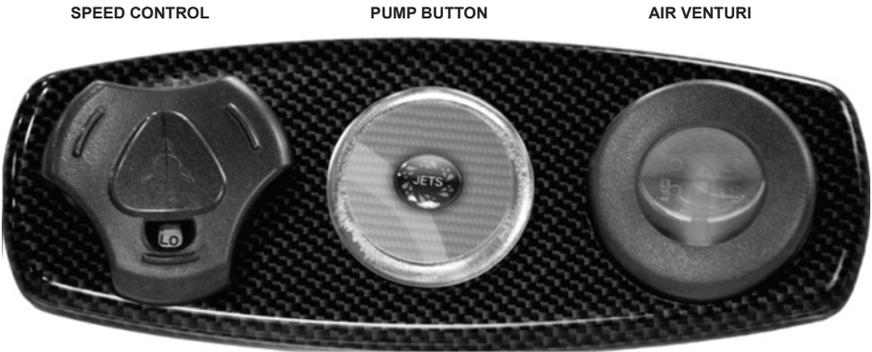

DIRECT FLOW CONTROLLER

THE MAIN SCREEN

Important information about spa operation can be seen quickly from the Main Screen.

The actual water temperature can be seen in large text and the desired or set temperature is shown in smaller text.

The time-of-day, ozone/uv, filter operation, messages, heat range, menu option and panel lock are also displayed on the main screen.

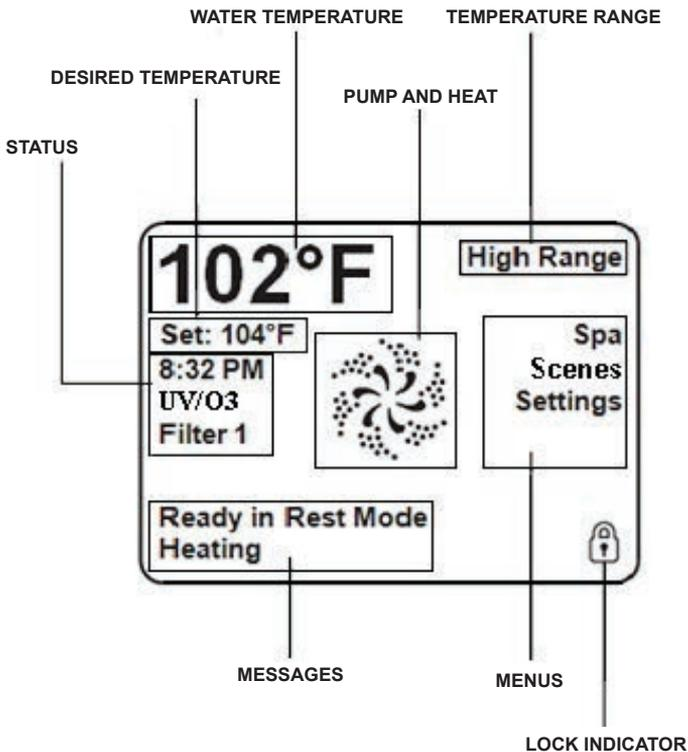

SPA OPERATION

There are three ways to operate the spa functions from the spa side. You can turn the spa pumps and lights from the topside though the buttons on the left hand side of the control panel, or you can use the spa menu using the navigation buttons or you can use the short cut setting. Certain functions (optional wave control) can only be controlled from the individual wave control buttons or through the menu option.

Using the spa function buttons:



Jets 1/Navigate up Button: The jets 1 button will operate pump number 1. First press of the Jets 1 button will activate pump 1. A second press of the Jets 1 button will deactivate pump1. If pump1 is not manually turned off by pressing the Jets 1 button it will automatically timeout after 15 minutes.



Jets 2/Navigate right Button: The jets 2 button will operate pump number 2. First press of the Jets 2 button will activate pump 2. A second press of the Jets 2 button will deactivate pump2. If pump2 is not manually turned off by pressing the Jets 2 button it will automatically timeout after 15 minutes.



Jets 3/Navigate down Button: The jets 3 button will operate pump number 3. First press of the Jets 3 button will activate pump 3. A second press of the Jets 3 button will deactivate pump3. If pump3 is not manually turned off by pressing the Jets 3 button it will automatically timeout after 15 minutes.



Jets 4/Navigate Left Button: The jets 4 button will operate pump number 4. First press of the Jets 4 button will activate pump 4. A second press of the Jets 4 button will deactivate pump 4. If pump4 is not manually turned off by pressing the Jets 4 button it will automatically timeout after 15 minutes.



Light

Light Button: The light button operates the L.E.D. Lights. First Press of the light button will turn on the lights. A second press of the light button will turn the lights off. The Island Spas lighting systems have different modes. To cycle through the different modes you must turn the light on and off, once the desired mode is selected, leave the light on. If the light is not manually turned off it will automatically timeout after 240 minutes.

SPA OPERATION



Temperature Up Button: The temperature up button will increase the set point temperature



Temperature Down Button: The Temperature down button will decrease the set point.



Menu Button: Will open the menu screen. Use the pump/menu navigation buttons to navigate the menu options.
Using the Spa Menu and navigation buttons:



Menu Button: Press the Menu Button to activate the menu.

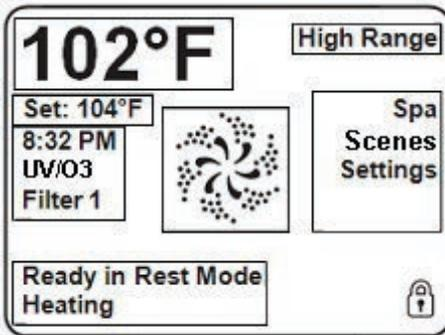

The main screen will change to spa operation screen

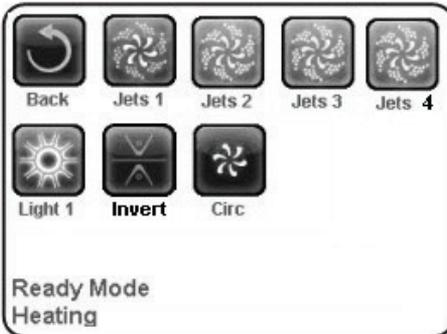

SPA OPERATION



Navigation Buttons

Use the navigation buttons to highlight the operation you would like to perform.

Icons and operation of the icons when highlighted and the select button is pressed.



Back

Back button: Will return you to the main menu



Jets 1

Jets 1: First press of the Select button will activate pump 1 (if pump is not currently on). A second press of the Select button will deactivate pump 1. If pump 1 is not manually turned off by pressing the Select button it will automatically timeout after 15 minutes.



Jets 2

Jets 2: First press of the Select button will activate pump 2 (if pump is not currently on). A second press of the Select button will deactivate pump 2. If pump 2 is not manually turned off by pressing the Select button it will automatically timeout after 15 minutes.



Jets 3

Jets 3: First press of the Select button will activate pump 3 (if pump is not currently on). A second press of the Select button will deactivate pump 3. If pump 3 is not manually turned off by pressing the Select button it will automatically timeout after 15 minutes.



Jets 4

Jets 4: First press of the Select button will activate pump 4 (if pump is not currently on). A second press of the Select button will deactivate pump 4. If pump 4 is not manually turned off by pressing the Select button it will automatically timeout after 15 minutes.

SPA/TEMPERATURE OPERATION



Light

Light: First Press of the select will turn on the lights. A second press of the select button will turn the lights off. The Island Spas lighting systems have different modes. To cycle through the different modes you must turn the light on and off, once the desired mode is selected, leave the light on. If the light is not manually turned off it will automatically timeout after 240 minutes.



Invert

Invert: Inverts the display to be viewed from outside the spa or inside the spa.

Temperature Operation



Temperature Up Button: The temperature up button will increase the set point temperature



Temperature Down Button: The Temperature down button will decrease the set point.

Temperature Range: The Temperature Range is displayed in the upper Right Hand corner of the display. This indicates what the range of the set point can be. Please see the section on adjusting setting to change the Temperature Range.

High Range: Set point can be set between 80°F and 104°F

Low Range: Set Point can be set between 50°F and 99°F

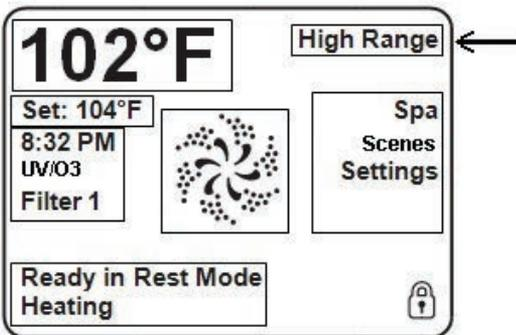

THE SETTINGS SCREEN

THE SETTINGS SCREEN

The Settings Screen is where all programming and other spa behaviors are controlled.



Menu Button: Press the Menu Button to activate the menu.



Jets 3/ Down navigation: Use the Down button and highlight Settings in the menu.

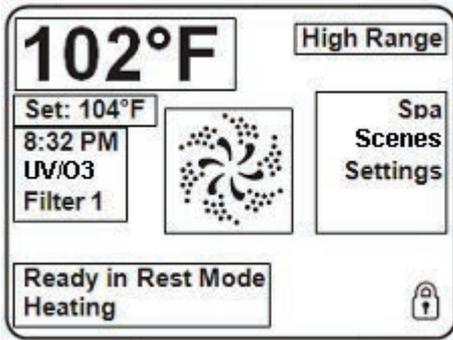

THE SETTINGS SCREEN

Temp Range

The first setting available to change is Temp Range. This system incorporates two temperature range settings. The specific range that is selected (High or Low) will be displayed in the upper right hand corner of the main screen.

High range can be set between 80°F and 104°F.

Low range can be set between 50°F and 99°F.



Jets 4/Navigate Left Button:

Press the left button to high light the Back Icon.

OR



Jets 3/Down navigation:

Press the down button to go to Heat Mode.

Heat Mode

Heat Mode indicates if the spa is Ready mode or Rest Mode. The heat mode will be displayed in the bottom right screen of the main screen display.

Ready Mode:

In ready mode the heater will maintain the set temperature. If your Platinum Elite spa is not programmed for 24 hours Filter it will turn on the circulation pump every half an hour to test the water temperature. If the water temperature is one degree below the set point the circulation pump will continue to run to bring the water temperature to the set point temperature. If the water temperature is at the set point temperature the circulation pump will turn off after 5 minutes. If your filtration cycle is set for 24 hours, the circulation pump will continue to run.

Rest Mode:

Will only allow the spa to heat during a filtration cycle.

If the spa is not in a filtration cycle, you can press the pump 1 pump to activate the heater. The spa will go into Ready mode for 1 hour and then go back to rest mode.

THE SETTINGS SCREEN



Jets 4/Navigate Left Button:
Press the left button to high light the Back Icon

-OR-



Jets 3/Down navigation:
Press the down button to go to Time of Day

Time of Day

When the time of day is highlighted.



Jets 2/Navigate right Button:
Press the Right button to go to the Time of Day Menu.

The screen will change to Time of Day settings.

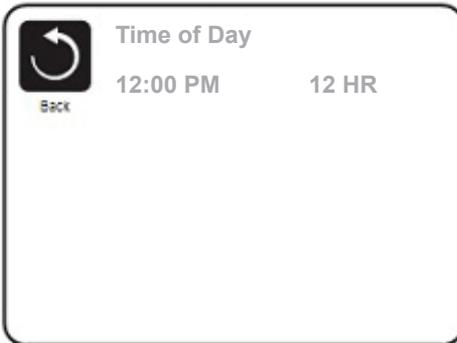

Jets 2/Navigate right Button:
Press the Right button to High light the hours.



Jets 1/Navigate up Button: To increase the hours.



Jets 3/Down Navigation: To decrease the hours

THE SETTINGS SCREEN

NOTE: To change from AM to PM you will need to adjust the hours past 12.



Jets 2/Navigate right Button:
Press the Right button to High Light the minutes.



Jets 1/Navigate up Button: To increase the minutes.



Jets 3/Down navigation: To decrease the minutes.



Jets 2/Navigate right Button:
Press the Right button to High Light the time format.

12HR: 12 hour format will be displayed.

24HR: 24 hour format will be displayed.



Jets 1/Navigate up Button: To change the time format.



Jets 3/Down navigation: To change the time format.



Jets 4/Navigate Left Button:
Press the left button to high light. Save Icon
(you will need to press it three times to high light the save button).



-OR-



Jets 3/Down navigation
Press the down button to highlight Cancel Icon.



When you are back on the Settings Menu.



Jets 3/ Down navigation:
Press the down button to go to Filter Cycle

THE SETTINGS SCREEN

Setting Filter Cycle

When the Filter Cycle is highlighted.



Jets 2/Navigate right Button:

Press the Right button to go to the Filter Cycle Menu.

The screen will change to Filter Cycle menu.



Jets 2/Navigate right Button:

Press the Right button to high light Filter Cycle 1 Start time Hour.



Jets 1/Navigate up Button:

To increase the Filter Cycle 1 Start time hours.



Jets 3/Down navigation:

To decrease the Filter Cycle 1 Start time hours.

(NOTE: To change AM and PM you will need to cycle the hours past 12).



Jets 2/Navigate right Button:

Press the Right button to high light Filter Cycle 1 Start time minutes.

(NOTE: Changing the minutes goes by 15 minute intervals).



Jets 1/Navigate up Button:

To increase the Filter Cycle 1 Start time Minutes.

THE SETTINGS SCREEN



Jets 3/Down navigation:
To decrease the Filter Cycle 1 Start time Minutes.



Jets 2/Navigate right Button:
Press the Right button to high light Filter Cycle 1 Start time minutes.

(NOTE: Changing the minutes goes by 15 minute intervals).



Jets 1/Navigate up Button: To increase the Run Time Hours.



Jets 3/Down navigation: To decrease the Run Time Hours.



Jets 2/Navigate right Button:
Press the Right button to high light Run Time minutes

(NOTE: Changing the minutes goes by 15 minute intervals).



Jets 1/Navigate up Button: To increase the Run Time Minutes.



Jets 3/Down navigation: To decrease the Run Time Minutes.

NOTE: The panel calculates the end time and displays it automatically.



Jets 2/Navigate right Button:
Press the Right button to highlight Filter Cycle 2.

THE SETTINGS SCREEN



Jets 1 / Navigate up Button: To tun Filter Cycle 2 on or off.

-OR-



Jets 3/Down navigation: To turn Filter Cycle 2 on or off.



Jets 2/Navigate right Button:

Press the Right button to high light Filter Cycle 2 Start time Hour.



Jets 1/Navigate up Button:

To increase the Filter Cycle 2 Start time hours.



Jets 3/Down navigation:

To decrease the Filter Cycle 2 Start time hours.

(NOTE: To change AM and PM you will need to cycle the hours past 12).



Jets 2/Navigate right Button:

Press the Right button to high light Filter Cycle 2 Start time minutes

(Note: Changing the minutes goes by 15 minute intervals)



Jets 1/Navigate up Button:

To increase the Filter Cycle 2 Start time Minutes.



Jets 3/Down navigation.



Jets 2/Navigate right Button:

Press the Right button to high light Run Time minutes.

(Note: Changing the minutes goes by 15 minute intervals).

THE SETTINGS SCREEN



Jets 1/Navigate up Button: To increase the Run Time Hours.



Jets 3/Down navigation: To decrease the Run Time Hours.

NOTE:The panel calculates the end time and displays it automatically.

In order to maintain sanitary conditions, as well as protect against freezing, the system will purge water from their respective plumbing by briefly running the pumps at the beginning of each filter cycle. If Filter Cycle is set to off, or filter cycle 1 is set to 24 hours. The second purge cycle will start at the time that is set for filtration cycle 2 start time.



Jets 2/Navigate right Button:

Press the Right button to high light Save Icon.



Save

-OR-



Jets 3/Down navigation:

Press the down button to highlight Cancel.



Cancel

When you are back on the Setting Menu.



Jets 3/ Down navigation:

Press the down button until Invert display is highlighted.

THE SETTINGS SCREEN

Invert Display

Normal: Display will be towards the inside of the spa.

Inverted; Display will be towards the outside of the spa.

When the display is inverted, the navigation buttons will also be inverted to work with the display.



Jets 3/ Down navigation:

Press the down button until Lock is highlighted.

Restricting Operations (LOCK)

The controller can be restricted to prevent unwanted use or changes.

There are two lock options.

Settings: will lock out anyone from changing the Set Temperature and other programming features all jet operations will work normally.

Panels: Prevents the topside from being used.

The screen will change to Lock Menu

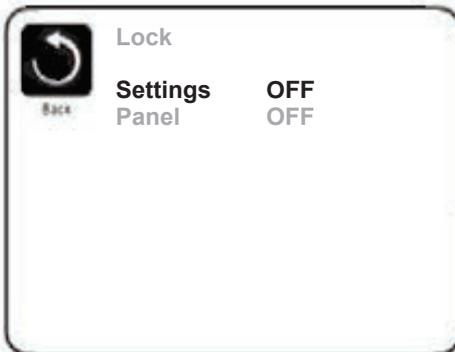

Jets 2/Navigate right Button:

Press the Right button to highlight Settings OFF/ON

THE SETTINGS SCREEN



Jets 3/Down navigation

Press the down button until Panel is highlighted.

The screen will change and go back to the main display.



To unlock the system.



Hit Menu Button



Jets 2/Navigate right Button:

Press the Right button to highlight Settings OFF/ON.

Then press the following buttons.



Jets 3/Down navigation:

Follow the above steps to unlock the panel.

Press 1 Button to highlight Settings



Jets 3 to unlock Settings

THE SETTINGS SCREEN



Jets 4/Navigate Left Button:

Press the left button to highlight Back Icon **Back**



Jets 3/Down navigation:

Press the Down Button until Hold is highlighted.

Hold

Hold mode is used to disable the pump during service functions, cleaning or replacing the filters. The hold will last for 1 hour unless the mode is exited manually.



Jets 4/Navigate Left Button:

Press the left button to highlight Back Icon **Back**



Jets 3/Down navigation:

Press the Down Button until Utilities is highlighted.

THE SETTINGS SCREEN

Utilities

The Utilities menu is used for trouble shooting and for technicians. As this is for service personnel we will just explain what each subject is. We do not recommend to change anything unless walked through the setting with a technician.

A/B Temps:

This will display the temperature on sensor A and B on the main display.

Fault Log:

This is the log of the last 24 actions on the spa. it is not necessary errors. If the GFCI breaker fails to operate as described, there is a possibility of an electric shock if the spa is used. Shut off the power at the main electrical service panel until the source of the problem has been identified and corrected by a licensed electrician or qualified spa technician.

GFCI Test:

This will cause the GFCI to trip to verify that is working correctly.



Jets 3/Down navigation:

Press the Down Button until Preference is highlighted.

Preference

The screen will change to the Preferences Menu.

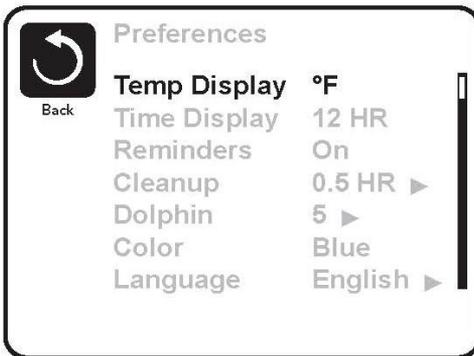

THE SETTINGS SCREEN

Temp Display



Jets 2/Navigate right Button:
Press the Right button to highlight Temp Display.

Press the select button to change from F° (Fahrenheit) to C° (Celsius) or from C° (Celsius) to F° (Fahrenheit).



Jets 3/Down navigation.
Press the Down Button until Time Display is highlighted.

Time Display

Press the select button to change from 12HR to 24HR or 24HR to 12HR time display.



Jets 3/Down navigation:
Press the Down Button until Reminder is highlighted.

Reminder

Press the select button to change The Reminders from On to Off or Off to On.

Note: The Reminders are messages that will appear in the bottom left hand corner of the main display, They are maintenance reminders for clean filter, check PH etc.

THE SETTINGS SCREEN

Dolphin (Not Used)



Jets 3/Down navigation:
Press the Down Button until Dolphin is highlighted.
This option is not available.

Color



Jets 3/Down navigation:
Press the Down Button until Color is highlighted.

Press the select button to change Back Ground color on the display.
Color options are: Blue, Red, Purple, Grey, and Green.

Language

This will change the language displayed on the screen to the language you choose.



Jets 3/Down navigation:
Press the Down Button until Language is highlighted.



Jets 3/Down navigation:
Press the Down Button until the Language you desire is highlighted.

Language options are; English, French, Spanish, and German.

Press the select button to choose highlighted language.



Jets 4/Navigate Left Button:
Press the left button to highlight Back Icon **Back**



Jets 3/Down navigation
Press the Down Button until the Information is highlighted.
Used for Technical and service personnel.

GENERAL MESSAGES

Most messages and alerts will appear at the bottom of the normally used screens.

Several alerts and messages may be displayed in sequence

Some messages can be reset from the panel. Message that can be reset will appear with a “right arrow” at the end of the message. This message can be selected by navigating to it and pressing the select button.

---°F ---°C

Water Temperature is Unknown

After the pump has been running for 1 minute the water temperature will be displayed.

Possible freezing condition

A potential freeze condition has been detected. All water devices are activated. In some cases the pump may turn on and off and the heater may operate during Freeze Protection. **This is an operational message, not an error code.**

The water is too hot – M029

The system has detected a spa water temperature of 110°F (43.3°C) or more, and spa functions are disabled. System will auto reset when the spa water temperature is below 108°F (42.2°C). Check for extended pump operation or high ambient temperature.

During the warmer months it is recommended to change the filter cycle duration to keep the spa from overheating with the high ambient temperature.

HEATER-RELATED MESSAGES

The water flow is low – M016

There may not be enough water flow through the heater to carry the heat away from the heating elements. Heater start up will begin again after about 1 minute.

Flow-Related Checks

Check for low water level, suction flow restriction (filters) closed valved, or trapped air.

The water flow has failed* – M017

There is not enough water flow through the heater to carry the heat away from the heating element and the heater has been disabled. After the flow problem has been resolved you must press any button to reset and begin the heater start up.

Flow-Related Checks

Check for low water level, suction flow restriction (filters) closed valved, or trapped air.

The heater may be dry* – M028

Possible dry heater or not enough water in the heater to start it. The spa is shut down for 15 minutes. Press any button to reset the heater start-up.

Flow-Related Checks

Check for low water level, suction flow restriction (filters) closed valved, or trapped air.

The heater is dry* – M027

There is not enough water in the heater to start it. The spa is shut down. After the problem has been resolved, you must clear the message to restart the heater.

Flow-Related Checks

Check for low water level, suction flow restriction (filters) closed valved, or trapped air.

SENSOR-RELATED/MISC. MESSAGES

The heater is too hot* – M030

One of the water temperature has detected 118°F (47.8°C) in the heater and the spa is shut down. You must clear the message when water is below 108°F (42.2°C)

Flow-Related Checks

Check for low water level, suction flow restriction (filters) closed valved, or trapped air.

SENSOR RELATED MESSAGES

Sensors are out of sync – M015

The temperature sensors may be out of sync. Call you dealer for service

Sensors are out of sync -- Call for service* – M026

The temperature sensors are out of sync. Call you dealer for service

Sensor A Fault, Sensor B Fault – Sensor A: M031, Sensor B: M032

The temperature sensors or sensor circuit has failed. Call you dealer for service.

MISCELLANEOUS MESSAGES

Communications error

The control panel is not receiving communication from the system. Call your dealer for service

Test software installed

The Control System is operating with test software. Call your dealer for service.

F or °C is replaced by °T

The Control System is in Test Mode. Call your dealer for service.

SYSTEM-RELATED MESSAGES

Program memory failure – M022

Call you dealer for service

The settings have been reset– M021

Call you dealer for service if this message appears on more than one power-up

The clock has failed –M020

Call you dealer for service

Configuration error (Spa will not Start Up)

Call you dealer for service

The GFCI test failed (System Could Not Test the GFCI) – M036

(North America Only) May indicate an unsafe installation. Call your dealer for service.

A pump may be stuck on – M034

Water may be overheated.

POWER DOWN THE SPA! DO NOT ENTER THE WATER!

Call your dealer for service..

Hot fault – M035

A pump appears to have been stuck on when the spa was last powered on. Water may be overheated.

POWER DOWN THE SPA! DO NOT ENTER THE WATER!

Call your dealer for service.

REMINDER MESSAGES

Not all messages may be displayed.

Check the pH

May appear on a regular schedule, i.e. every 7 days.

Check pH with a test kit and adjust pH with the appropriate chemicals.

Check the sanitizer

May appear on a regular schedule, i.e. every 7 days.

Check sanitizer level and other water chemistry with a test kit and adjust with the appropriate chemicals.

Clean the filter

May appear on a regular schedule, i.e. every 30 days.

Clean the filter media as instructed by the manufacturer.

Test the GFCI (or RCD)

May appear on a regular schedule, i.e. every 30 days.

The GFCI or RCD is an important safety device and must be tested on a regular basis to verify its reliability.

Every user should be trained to safely test the GFCI or RCD associated with the hot tub installation.

Change the water

May appear on a regular schedule, i.e. every 90 days.

Change the water in the spa on regular basis to maintain proper chemical balance and sanitary conditions.

Clean the cover

May appear on a regular schedule, i.e. every 180 days.

Vinyl covers should be cleaned and conditioned for maximum life.

Change the filter

May appear on a regular schedule, i.e. every 365 days.

Filters should be replaced occasionally to maintain proper spa function and sanitary condition.

DIRECT FLOW CONTROL PANEL

SPEED CONTROL

PUMP BUTTON

AIR VENTURI



The Direct Flow individual control panels let you control the spa from the seat.

Speed Control:

The speed control will change the water flow from the jets, from a vigorous massage to a softer massage.

(NOTE: For the speed control to work properly all jets associated with that seat must be in the open position).

Pump Button:

This activates the pump associated with that control. If the pump is not manually turned off after 15 minutes the pump will automatically time out.

Air Venturi:

The Air Venturi will add air to the jets and add pressure to the massage.

(NOTE: Pump number 5 (foot dome) speed control is affected by the diverter valve. Speed control will only work if the diverter valve is in the center).

MAINTAINING YOUR SPA

DRAINING YOUR SPA

Your spa needs to be drained, cleaned, waxed, and refilled about every six months. More frequent water changes may be necessary if bather load is heavy. A hose bib has been provided below the left side of your front access panel, to assist you in draining your spa.

1) Turn off the power to your spa.
If you fail to turn the power off, vital components could be damaged. Do not leave an empty spa exposed for long periods of time in hot, sunny weather.



2) Pull and continue turning counter clockwise till cap is removed.



3) Connect the hose



4) Pull nozzle to ensure opening of nozzle.



5) Check the garden hose end to see if water is flowing. If water is not flowing, check the hose for kinks. Also check to see if valve is in the full open position.

CAUTION: The chemical content and temperature of the water will cause damage to certain vegetation. We do not recommend that you drain your spa onto plants or lawns. If you choose to do this, please remove your spa cover and allow spa to cool for a minimum of 24 hours with the spa turned off.

PILLOW CARE

Remove and clean the pillows with soapy water and a soft cloth when needed. Use a vinyl conditioner once a month. Remove pillows when doing chemical shock treatment.

MAINTAINING YOUR SPA

JET CARE

We recommend that you clean your jets when you drain your spa. However, if you do need to clean your jets in between this can be accomplished with a full spa.

1) To remove the jet inserts turn the jet counterclockwise until it stops. Continue to turn the jet past the stop point to loosen it from the spa. The insert will now pull out.



2) Soak jet inserts in a mixture of 1 part vinegar to two parts warm water for 2-3 hours. Periodically rotate the spinner nozzle to break up residue in the jets.

3) Rinse the jet inserts with a standard garden hose.

4) To reinstall the jets, insert jet into jet body and turn clockwise until fully seated then tug to make sure it is seated properly. You can then continue to turn clock-wise until it stops.



NOTE: A jet with stainless steel escutcheons can be slippery. You can use a soft cloth or jar-opening pad to assist in removing and installing the jet.

MAINTAINING YOUR SPA

REMOVING, INSTALLING AND CLEANING FILTERS

These are the steps needed to successfully replace your filters. You should replace your disposable spa filters and clean your nondisposable filters every four months.

- 1) Turn off all power to your spa and remove the filter lid by lifting it out towards you.
- 2) Turn the filter counterclockwise and remove it from the filter well.
- 3) Dispose of the used filter.



- 4) Place the new filter into position and turn clockwise to fasten. **DO NOT** over-tighten.

- 5) Follow the directions 1) and 2) for the pleated filter cartridge. You then rinse the filter with a garden hose and soak the filter in a mixture of one pint of filter cleaner with 2.5 gallons of water for at least 12 hours. The filter must be completely submerged. You then follow the directions 4) and 5) to replace the filter.



WARNING: Power to your spa must be turned off prior to removing your filters. The suction at the filter is extremely strong and can cause injury if there is no filter. **NEVER** run your spa without the filters properly installed. Injury to person and damage to the equipment can occur. Any damage to equipment due to this circumstance will not be covered under warranty.

NOTE: You can upgrade your filter to a 75 Sqft. filter. Please see your Artesian dealer, Part# 06-007-12 (standard) or 06-008-12 (Nature2) option.

MAINTAINING YOUR SPA

WINTERIZING YOUR SPA

It is not recommended that you drain your spa completely during freezing conditions. We recommend that you leave your spa full of water with the power on to keep the tub from freezing. If you decide to drain your spa during freezing conditions, contact your dealer for help. Contact your Artesian dealer before refilling a drained spa in freezing temperature.

WARNING: Damage to your spa caused by freezing is NOT covered under warranty. Please contact your local Artesian dealer to assist you in winterizing your spa.

SPA CABINET CARE

Your spa comes standard with a KingWood, or faux wood, cabinet. This cabinet requires no maintenance. You may wish to clean the cabinet with mild soap and water from time to time.

1) Gently wash the cabinet with mild soap and water and allow to dry completely.

NOTE: Do not apply any solid type finish such as shellac or varnish. After weathering, these types of finishes will crack and/or turn yellow. To refinish the wood, you will need to completely strip the finish before applying the new one. Use only the stain recommended by your Artesian dealer for refinishing your spa.

CLEANING YOUR SPA INTERIOR

It is important to clean the interior of your spa every time it is drained to help preserve the sheen of your spa's surface. However, it is important that you do not use any abrasive cleaners or strong chemicals. Your Artesian Spas authorized dealer will be able to supply you with the proper cleaning solution for your spa. After cleaning, make sure all residues are removed prior to filling the spa. This will help prevent sudsing and improper chemical balance.

MAINTAINING YOUR SPA

COVER CARE

Cleaning of your spa cover is an important part of routine maintenance. Dirt acts as an abrasive to the vinyl topcoat, and can also cause wear to folds, seams, and stitching. Mildew growing on damp, dirty vinyl will begin to actually root in the fabric, accelerating failure. Follow this simple routine for cleaning, prior to application of vinyl protectant:

- 1) Rinse with cool water using a garden hose.
- 2) Spray with a gentle, non-foaming cleaner and wipe clean. Never use laundry detergent, abrasives, alcohols, dish soaps or harsh cleaners. These can actually remove some of the topcoat and cause premature vinyl failure.
- 3) For stubborn dirt, use a non-abrasive sponge.
- 4) Rinse again thoroughly with water and allow to dry.
- 5) Repeat monthly, or as needed.

Your vinyl cover is affected by the UV in sunlight. Periodic treatment with a liquid protectant will extend the life of your spa. The wrong kind of protectant can be more harmful than no protectant at all. Keep any product away from your spa that is labeled “flammable,” that contains any type of oil, or that leaves a waxy coating on your cover.

Never stand or sit on the cover and never drag it over abrasive surfaces. Lift cover only by the handles provided.

CHEMICAL TREATMENT OF WATER

Water from your tap is fine for showers, bathing and drinking. However, in a contained recirculating system such as in a spa, water must be treated with chemicals. The main purpose of chemical treatment is to keep the water sanitary and to maintain a specific balance of the water. Proper balance ensures that the water will not cause irritation to the users or harm the spa's components. Chemical treatment does have its limitations. When water evaporates, chemical residues are left behind. As the levels of the residues combine with other types of residue, such as body oil and detergents, your water becomes increasingly difficult to maintain.

MAINTAINING YOUR SPA

CHEMICAL TREATMENT OF WATER

Because of this residual effect, at some point it becomes easier and more cost-effective to drain, clean and refill your spa with new water. We recommend that the water be changed at least every six months. At this time you should also clean or replace your filters. If your spa has a frequent and/or heavy bather load, it may be necessary to drain and fill your spa more often.

WARNING: Spa damage due to improper chemicals is not covered under warranty.

CAUTION: The chemicals used to maintain the pH balance of the water and to sanitize the water can be dangerous. Always follow these basic guidelines when handling the chemicals:

1. Always read and follow the directions on the label, unless directed otherwise.
2. Never mix different chemicals.
3. Do not exceed the recommended amounts of chemicals—follow the directions on the label.
4. Keep all chemicals out of the reach of children and pets.
5. Keep containers closed tightly when not in use.
6. Never add water to the chemicals—always add the chemicals to the water as directed.
7. Always store chemicals in a cool, dry place.

ARTESIAN SPAS ISLAND ELITE WARRANTY

This section is a description of your warranty. Here you will find descriptions of what is covered under your Island Elite Class Spa warranty and what can void your warranty. **PLEASE READ THE WARRANTY THOROUGHLY.** Please take a moment to register your warranty. You can register on line at <http://www.artesianspas.com>, click on owner login or you mail in the warranty registration card attached to this manual. For warranty outside USA and Canada, please refer to your countries Artesian Distributor.

LIFETIME STRUCTURE WARRANTY

Island Elite Class Spas carry a lifetime structure warranty. The structure is defined as the fiberglass vessel below the exposed material finish. The manufacturer warrants the spa against loss of water due to a defect in the spa structure, for the lifetime of the spa. In the event of a defect in the material and/or workmanship, the spa structure will be repaired or replaced at the discretion of the manufacturer. **THIS WARRANTY IS GIVEN ONLY TO THE ORIGINAL OWNER, AND TERMINATES UPON TRANSFER OF OWNERSHIP. COMMERCIAL APPLICATIONS ARE EXCLUDED FROM THIS AND ALL WARRANTIES.**

If the spa structure is defective and must be replaced, it will be returned to the factory. The original, installed equipment (this includes the frame, skirt, and all equipment) will be reinstalled. If new equipment is desired, there will be additional charges to the customer. If the frame and/or skirt of the spa has been badly damaged, there will be additional charges to the spa owner for repairs or replacement. When a spa needs to be returned to the factory for repair, the cost of one way freight to the company will be at the spa owner's expense. The manufacturer will not pay for removal, installation, cranes, construction, de-construction, or any other cost associated with access, egress, or ingress, of the spa at the customer's home. The manufacturer reserves the right to an on-site inspection by its authorized representative. In the unlikely event a shell or spa must be replaced, all warranties (shell, surface, electrical and plumbing) date back to the original start date of the warranty. The warranty period starts either the day of delivery to the customer or eighteen (18) months from the date of manufacturing, whichever date comes first.

SEVEN-YEAR SURFACE WARRANTY

The spa surface is described as the exposed material finish. The manufacturer warrants the spa surface to be free from defects in the material and workmanship, such as blistering, cracking, or delaminating, this does not cover micro-crazing, under normal use and maintenance

for a period of seven years from the original start date of the warranty. The warranty period starts either the day of delivery to the customer or eighteen (18) months from the date of manufacturing, whichever date comes first. ***THIS WARRANTY IS GIVEN ONLY TO THE ORIGINAL OWNER, AND TERMINATES UPON TRANSFER OF OWNERSHIP. COMMERCIAL APPLICATIONS ARE EXCLUDED FROM THIS AND ALL WARRANTIES.***

The spa must be set on a level solid surface that is sufficient to support the entire length and width of the spa. Standard building practices must be followed. Damage caused by failure to have a leveled and supported foundation under the spa is not covered under warranty. The manufacturer does not warrant problems associated with prolonged exposure to the sun and/or use of any sanitization or ozone system not approved by the manufacturer. Damage to the spa surface caused by leaving the spa uncovered and empty of water with direct sunlight exposure will terminate this warranty. Any alteration to any system, either electrical, plumbing, or mechanical, or over use of chemicals, or any other problems caused by external source are not covered under warranty. Other exclusions may apply.

Normally problems associated with material and workmanship can and will be repaired. If the spa surface is repaired, the repair is limited to the affected area only, and there is no guarantee against discoloration or fading. The decision to repair will be made by the manufacturer and its field representative after a review of the facts, pictures, or any other data presented by the dealer or customer. In all cases, pictures of the affected area and foundation of the spa must be provided before any decisions to repair or replace can be made. In the unlikely event a shell or spa must be replaced, all warranties (shell, surface, electrical and plumbing) date back to the original date of installation. If it is determined that the surface is to be replaced, the same conditions and terms as outlined in the shell warranty will apply.

ARTESIAN SPAS ISLAND ELITE WARRANTY

FIVE-YEAR ELECTRICAL WARRANTY

(i.e. pumps, equipment packs, heater, topside control, etc). The manufacturer warrants all electrical equipment to be free from defect and workmanship for five years from the original start date of the warranty. The warranty period starts either the day of delivery to the customer or eighteen (18) months from the date of manufacturing, whichever date comes first. ***THIS WARRANTY IS GIVEN ONLY TO THE ORIGINAL OWNER, AND TERMINATES UPON TRANSFER OF OWNERSHIP. COMMERCIAL APPLICATIONS ARE EXCLUDED FROM THIS AND ALL WARRANTIES.***

The stereo, speakers, stereo power supply, L.E.D. lighting, light bulbs, fuses, and Ozone are not included in the warranty, but are covered under a separate warranty. Damage caused by weather, poor water chemistry, and/or improper maintenance will not be covered under this warranty. Alterations or replacements of components installed in the spa that are not purchased and/or approved by the manufacturer including incorrect wiring, will terminate the spa warranty.

FIVE YEAR PLUMBING WARRANTY

The plumbing is described as all piping, jet bodies, valve bodies and air controls. The manufacturer warrants all plumbing for a period of five years from the original start date of the warranty. The warranty period starts either the day of delivery to the customer or eighteen (18) months from the date of manufacturing, whichever date comes first. ***THIS WARRANTY IS GIVEN ONLY TO THE ORIGINAL OWNER, AND TERMINATES UPON TRANSFER OF OWNERSHIP. COMMERCIAL APPLICATIONS ARE EXCLUDED FROM THIS AND ALL WARRANTIES.***

Jet internals, valve handles, and other such items are regular maintenance items. They are covered for the item only, labor is not covered for these items. Damage caused by weather, poor water chemistry, and/or improper maintenance will not be covered under this warranty.

TWO YEAR CABINET WARRANTY

The spa cabinet is described as the outer material encasing the spa structure. The manufacturer warrants it to be free from defects in material and/or workmanship from the original start date of the warranty. The warranty period starts either the day of delivery to the customer or eighteen (18) months from the date of manufacturing, whichever date comes first.

THIS WARRANTY IS GIVEN ONLY TO THE ORIGINAL OWNER, AND TERMINATES UPON TRANSFER OF OWNERSHIP. COMMERCIAL APPLICATIONS ARE EXCLUDED FROM THIS AND ALL WARRANTIES.

This warranty does not cover normal darkening, staining, or aging. The spa cabinet requires care and maintenance by the consumer. Damage caused by weather, poor water chemistry, and/or improper maintenance will not be covered under this warranty.

OTHER ITEMS NOT COVERED IN THIS WARRANTY

Some items are not covered in this warranty. These items either have a different warranty, or are warranted through the manufacturer of that item.

STEREO AND STEREO COMPONENTS

The stereo and stereo components, including speakers, sub woofer, power supply, wire harness, and remote control are covered for 30 days from the original start date of the warranty. The warranty period starts either the day of delivery to the customer or eighteen (18) month from the date of manufacturing, whichever date comes first. This warranty does not cover damage to a stereo or stereo component from abuse, poor reception, or damage caused by putting a wet CD into the stereo. If a stereo is replaced under this warranty, the manufacturer reserves the right to replace the unit with another like unit, but not necessarily the same stereo manufacturer. No spa will be replaced for a failed stereo. The stereo does not affect the performance of the spa.

NOTE: For all operating instructions see the stereo manufacturer's owner's manual included with the spa.

OZONATOR

The ozonator is covered for one year from the original start date of the warranty. The warranty period starts either the day of delivery to the customer or eighteen (18) month from the date of manufacturing, whichever date comes first.

SPA COVER

The spa cover manufacturer warrants the spa cover skin for one year from the original start date of the warranty. The warranty period starts either the day of delivery to the customer or eighteen (18) month from the date of manufacturing, whichever date comes first.

ARTESIAN SPAS ISLAND ELITE WARRANTY

Do not return the spa cover to the manufacturer. This will delay the replacement or repair of the cover. The spa manufacturer is not responsible for lost covers.

LIGHTING

The LED lighting is guaranteed to work upon delivery. There is no warranty covering the LED lighting.

PERFORMANCE

In the event of any defect covered by this LIMITED warranty, a May Manufacturing LLC, authorized agent will correct such defect within the terms and conditions contained herein. There will be no charge for parts or labor within the above terms. However, travel charges that occur will not be covered under terms and conditions by the warranty. If it is determined by May Manufacturing LLC that the repair of the product is not feasible, a replacement spa equal to the value of the original purchase price will be provided. Cost for removal of the defective spa and delivery and installation of the replacement spa is the responsibility of the homeowner and will not under any circumstances be covered by May Manufacturing LLC.

LIMITATIONS

This warranty is void if this Artesian Spa has been subjected to alteration, misuse, or repairs have been performed by anyone other than an authorized agent of May Manufacturing LLC. Misuse or abuse is defined as: use of the spa in a nonresidential application, water temperature outside the range of 32° F to 110° F, damage caused by clogged or dirty filter cartridges, damage to the spa from an absence of a hard cover, damage to components from improper pH, use of any type of acid, or from chemical imbalance. ACTS OF NATURE are not covered under this warranty.

Note: Warranty on 50Hz spas excludes labor.
(Outside US and Canada)

DISCLAIMER

May Manufacturing LLC, or its agent shall not be liable for any injury, cost or other damage, whether incidental or consequential, arising out of any defect covered by the LIMITED WARRANTY. The liability of May Manufacturing LLC under this LIMITED WARRANTY shall not exceed the original amount paid for the spa.

LEGAL REMEDIES

This LIMITED WARRANTY gives specific rights, and other rights that may apply and will vary from state to state.

WHAT IS NOT COVERED UNDER YOUR WARRANTY

The following is a general overview of non-warranty items and work. This is not an all-inclusive list.

Diagnosis of Spa Problems
Fuses
Light Bulbs of Any Kind
Removing a Spa from a Structure
Pillows
Filters
Chemical Misuse / Damage
Filter Lids
Any Part not Purchased from Artesian Spas
Jet Inserts
Valve Handles
Pump Seals
Draining and filling the Spa
Acts of Nature
Travel Charges
Cabinet Screws
Incorrect Wiring
Shipping Charges

THIS WARRANTY IS GIVEN ONLY TO THE ORIGINAL OWNER, AND TERMINATES UPON TRANSFER OF OWNERSHIP. COMMERCIAL APPLICATIONS ARE EXCLUDED FROM THIS AND ALL WARRANTIES.

Any alteration of the spa that has not been pre-authorized by the manufacturer will void all warranties. If the manufacturer approves an alteration, verify that this alteration is covered under warranty. Damage caused by moving a spa that is blocked in or that has been recessed, along with additional charges for labor, is not covered by this warranty.

ARTESIAN SPAS ISLAND ELITE PARTS LIST & DIAGRAM

ITEM #	PART NUMBER	DESCRIPTION	ITEM #	PART NUMBER	DESCRIPTION
(1)	33-1310-08	SPA PACK	(9)	08-1370-52 01-0017-30	ON/OFF VALVE AIR CONTROL
(2)	OP24-0216-08	HEATER	(10)	03-3501-52K	5" HELIX ROTO JET
(3)	33-1319-08	TP 800 TOPSIDE		03-3401-52K	4.5" HELIX ROTO JET
(4)	21-0050-81	6.0 HP 1-SPEED PUMP 3.0 HP 1-SPEED PUMP LAING CIRC PUMP		03-3301-52K	3" HELIX ROTO JET
	21-0025-81			03-3304-52K	3" HELIX DIRECT JET
	21-0008-19			03-3307-52K	3" HELIX MESSAGE JET
(5)	06-0006-12	BLUE FILTER PURPLE FILTER FILTER CAP LARGE PURPLE FILTER NATURE 2	03-3201-52K	2.75" HELIX JET	
	06-0055-12		03-0764-30	7" ULTRA BLASTER JET	
	06-0050-48		(11)	SPA SERIAL NUMBER	
	06-0056-12		STEREO ITEMS	33-1315-08	WI-FI MODULE
OP96-0017-00P	33-0257-16	AQUATIC AV STEREO			
(6)	25-0031-40	AOP		33-0001-17	BLUETOOTH STEREO
	(7)	26-1303-85	LOUNGE PILLOW NECK PILLOW WATERFALL PILLOW	33-0190-07	INFINITY BLUETOOTH STEREO
26-1304-85		33-0090-98		INFINITY BLUETOOTH STEREO REMOTE	
26-1305-85		33-0242-16		POWER SUPPLY	
(8)		08-1360-52		2" DIVERTER VALVE	33-0085-56
				33-0191-07	GRAY SPEAKER
				33-0246-16	INFINITY SPEAKER
33-0243-16				SPEAKER COVER	
			33-0102-55	SUBWOOFER BOX	
					BASS TUBE

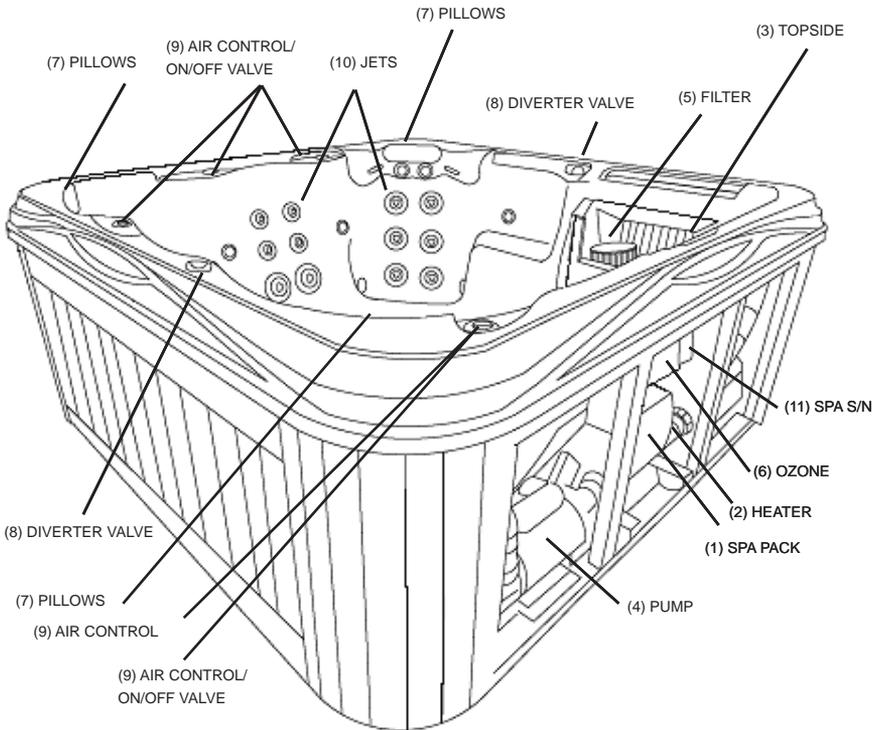

SPA & WARRANTY REGISTRATION

Activate Product Warranty & Download Owner's Manuals

Please activate your warranty and register your spa by mailing in this reply card, or go online at www.ArtesianSpas.com and click on owner login.

(Serial # is required below and can be located on the bottom kick plate of the spa, or can be found within the cabinet next to the equipment on a white placard attached to the frame.)

Name _____

Address _____

City _____ State _____ Zip _____

Phone Number _____

Date of Installation _____ Spa Serial Number (required) _____

Spa Model _____

Your Dealers Name and Location _____

Optional Questions:

What other spa brands did you consider buying? _____

How many people are in your household? _____

What is your age bracket? 25-30 31-40 41-50 51-60 61-70 71+

What is your reason for purchasing a spa? Health Benefits Stress Relief Relaxation

Other: _____

Place
Stamp
Here

Please do not send products or
other correspondence to the
address below.

ARTESIAN SPAS
Attn: Customer Care Department
4720 N. Lamb Blvd.
Las Vegas, NV 89115



ARTESIAN SPAS™

EXPERIENCE THE ULTIMATE

4720 N. Lamb Blvd.
Las Vegas, Nevada 89115
www.ArtesianSpas.com